

TEST REPORT

CERTIFICATE OF CONFORMITY

Standard: EN 55032: 2015+A11:2020, Class A
EN 61000-3-2: 2014, Class A
EN IEC 61000-3-2: 2019+A1:2021, Class A
EN 61000-3-3: 2013+A1:2019+A2:2021
EN 55035: 2017+A11:2020

Report No.: CEBDBO-WTW-P23120002

Product: High-Performance Fanless System

Brand: Vecow

Model No.: IVX-1000-ICY

Series Model: IVX-1XXXXXXXXXXXXXXXXX ("X" can be 0-9, A-Z or blank for marketing purpose)

Received Date: 2023/12/1

Test Date: 2023/12/18 ~ 2024/7/6

Issued Date: 2024/7/15

Applicant: Vecow Co., Ltd.

Address: 3F., No. 10, Jiankang Rd., Zhonghe Dist., New Taipei City 23586, Taiwan

Issued By: Bureau Veritas Consumer Products Services (H.K.) Ltd., Taoyuan Branch
Lin Kou Laboratories

Lab Address: No. 47-2, 14th Ling, Chia Pau Vil., Lin Kou Dist., New Taipei City, Taiwan

Test Location: No. 47-2, 14th Ling, Chia Pau Vil., Lin Kou Dist., New Taipei City, Taiwan

Approved by: _____

Jim Hsiang

Jim Hsiang / Associate Technical Manager

Date: _____

2024/7/15

This test report consists of 91 pages in total. It may be duplicated completely for legal use with the approval of the applicant. It should not be reproduced except in full, without the written approval of our laboratory. The test results in the report only apply to the tested sample. The test results in this report are traceable to the national or international standards.



Prepared by : Vivian Chen / Senior Specialist

This report is governed by, and incorporates by reference, the Conditions of Testing as posted at the date of issuance of this report at <http://www.bureauveritas.com/home/about-us/our-business/cps/about-us/terms-conditions/>, and is intended for your exclusive use. Any copying or replication of this report to or for any other person or entity, or use of our name or trademark, is permitted only with our prior written permission. This report sets forth our findings solely with respect to the test samples identified herein. The results set forth in this report are not indicative or representative of the quality or characteristics of the lot from which a test sample was taken or any similar or identical product unless specifically and expressly noted. Our report includes all of the tests requested by you and the results thereof based upon the information that you provided to us. Measurement uncertainty is only provided upon request for accredited tests. Statements of conformity are based on simple acceptance criteria without taking measurement uncertainty into account, unless otherwise requested in writing. You have 60 days from date of issuance of this report to notify us of any material error or omission caused by our negligence or if you require measurement uncertainty; provided, however, that such notice shall be in writing and shall specifically address the issue you wish to raise. A failure to raise such issue within the prescribed time shall constitute your unqualified acceptance of the completeness of this report, the tests conducted and the correctness of the report contents.

Table of Contents

Release Control Record	4
1 Certificate	5
2 Summary of Test Results	6
2.1 Performance Criteria	7
2.2 Measurement Uncertainty	10
2.3 Supplementary Information	10
3 General Information	11
3.1 Description of EUT	11
3.2 Primary Clock Frequencies of Internal Source	11
3.3 Features of EUT	11
3.4 Operating Modes of EUT and Determination of Worst Case Operating Mode	12
3.5 Test Program Used and Operation Descriptions	13
3.6 Connection Diagram of EUT and Peripheral Devices	14
3.7 Configuration of Peripheral Devices and Cable Connections	16
4 Test Instruments	20
4.1 Conducted Emissions from Power Ports	20
4.2 Conducted Emissions from Wired Network Ports	21
4.3 Radiated Emissions up to 1 GHz	22
4.4 Radiated Emissions above 1 GHz	23
4.5 Harmonic Current Measurement	23
4.6 Voltage Fluctuations and Flicker Measurement	23
4.7 Electrostatic Discharges (ESD)	24
4.8 Radio Frequency Electromagnetic Field (RS)	25
4.9 Fast Transients Common Mode (EFT)	26
4.10 Surges	26
4.11 Radio Frequency Common Mode (CS)	26
4.12 Power Frequency Magnetic Field (PFMF)	27
4.13 Voltage Dips and Interruptions (DIP)	28
5 Limits of Test Items	29
5.1 Conducted Emissions from Power Ports	29
5.2 Conducted Emissions from Wired Network Ports	29
5.3 Radiated Emissions up to 1 GHz	29
5.4 Radiated Emissions above 1 GHz	30
5.5 Harmonic Current Measurement	30
5.6 Voltage Fluctuations and Flicker Measurement	31
5.7 General immunity requirements	32
6 Test Arrangements	34
6.1 Conducted Emissions from Power Ports	34
6.2 Conducted Emissions from Wired Network Ports	35
6.3 Radiated Emissions up to 1 GHz	38
6.4 Radiated Emissions above 1 GHz	39
6.5 Harmonic Current Measurement	40
6.6 Voltage Fluctuations and Flicker Measurement	40
6.7 Electrostatic Discharges (ESD)	41
6.8 Radio Frequency Electromagnetic Field (RS)	43
6.9 Fast Transients Common Mode (EFT)	44
6.10 Surges	45
6.11 Radio Frequency Common Mode (CS)	47
6.12 Power Frequency Magnetic Field (PFMF)	49
6.13 Voltage Dips and Interruptions (DIP)	50
7 Test Results of Test Item	51
7.1 Conducted Emissions from Power Ports	51
7.2 Conducted Emissions from Wired Network Ports	53



7.3	Radiated Emissions up to 1 GHz	57
7.4	Radiated Emissions above 1 GHz.....	59
7.5	Harmonic Current Measurement.....	61
7.6	Voltage Fluctuations and Flicker Measurement	62
7.7	Electrostatic Discharges (ESD).....	63
7.8	Radio Frequency Electromagnetic Field (RS).....	69
7.9	Fast Transients Common Mode (EFT).....	69
7.10	Surges	70
7.11	Radio Frequency Common Mode (CS).....	71
7.12	Power Frequency Magnetic Field (PFMF).....	72
7.13	Voltage Dips and Interruptions (DIP).....	72
8	Pictures of Test Arrangements	73
8.1	Conducted Emissions from Power Ports.....	73
8.2	Conducted Emissions from Wired Network Ports	74
8.3	Radiated Emissions up to 1 GHz	78
8.4	Radiated Emissions above 1 GHz.....	79
8.5	Harmonic Current Measurement.....	80
8.6	Voltage Fluctuations and Flicker Measurement	80
8.7	Electrostatic Discharges (ESD).....	81
8.8	Radio Frequency Electromagnetic Field (RS).....	82
8.9	Fast Transients Common Mode (EFT).....	83
8.10	Surges	86
8.11	Radio Frequency Common Mode (CS).....	87
8.12	Power Frequency Magnetic Field (PFMF).....	90
8.13	Voltage Dips and Interruptions (DIP).....	90
9	Information of the Testing Laboratories	91



Release Control Record

Issue No.	Description	Date Issued
CEBDBO-WTW-P23120002	Original release.	2024/7/15

1 Certificate

Product: High-Performance Fanless System

Brand: Vecow

Test Model: IVX-1000-ICY

Series Model: IVX-1XXXXXXXXXXXXXXXXX (“X” can be 0-9, A-Z or blank for marketing purpose)

Sample Status: Mass Production

Applicant: Vecow Co., Ltd.

Test Date: 2023/12/18 ~ 2024/7/6

Standard: EN 55032: 2015+A11:2020, Class A
EN 61000-3-2: 2014, Class A
EN IEC 61000-3-2: 2019+A1:2021, Class A
EN 61000-3-3: 2013+A1:2019+A2:2021
EN 55035: 2017+A11:2020

Measurement procedure: EN 61000-4-2: 2009 / IEC 61000-4-2: 2008 ED. 2.0
EN IEC 61000-4-3: 2020 / IEC 61000-4-3: 2020 ED. 4.0
EN 61000-4-4: 2012 / IEC 61000-4-4: 2012 ED. 3.0
EN 61000-4-5: 2014+A1:2017 / IEC 61000-4-5: 2017 ED. 3.1
EN 61000-4-6: 2014+AC:2015 / IEC 61000-4-6: 2013 ED. 4.0
EN 61000-4-8: 2010 / IEC 61000-4-8: 2009 ED. 2.0
EN IEC 61000-4-11: 2020+AC:2020 / IEC 61000-4-11: 2020 ED. 3.0

The above equipment has been tested by **Bureau Veritas Consumer Products Services (H.K.) Ltd., Taoyuan Branch**, and found compliance with the requirement of the above standards. The test record, data evaluation & Equipment Under Test (EUT) configurations represented herein are true and accurate accounts of the measurements of the sample’s EMC characteristics under the conditions specified in this report.

2 Summary of Test Results

The test items that the EUT need to perform in accordance with its interfaces, evaluated functions are as follows:

Standard	Test Item	Result	Remark
EN 55032	Conducted Emissions from Power Ports	Pass	Minimum passing Class A margin is -27.04 dB at 0.23995 MHz
EN 55032	Conducted Emissions from Wired Network Ports	Pass	Minimum passing Class A margin is -8.80 dB at 1.17159 MHz
EN 55032	Radiated Emissions up to 1 GHz	Pass	Minimum passing Class A margin is -3.74 dB at 212.81 MHz
EN 55032	Radiated Emissions above 1 GHz	Pass	Minimum passing Class A margin is -0.68 dB at 5999.98 MHz
EN 61000-3-2 EN IEC 61000-3-2	Harmonic Current Measurement	Pass	Meets Class A Limit
EN 61000-3-3	Voltage Fluctuations and Flicker Measurement	Pass	$P_{st} \leq 1.00$ $d_{max} \leq 4.00\%$ $P_{lt} \leq 0.65$ $d_c \leq 3.30\%$ $T_{max} \leq 500$ ms
IEC 61000-4-2	Electrostatic Discharges (ESD)	Pass	For EN 55035 Performance Criteria B
IEC 61000-4-3	Radio Frequency Electromagnetic Field (RS)	Pass	For EN 55035 Performance Criteria A
IEC 61000-4-4	Fast Transients Common Mode (EFT)	Pass	For EN 55035 Performance Criteria A
IEC 61000-4-5	Surges	Pass	For EN 55035 Performance Criteria A
IEC 61000-4-6	Radio Frequency Common Mode (CS)	Pass	For EN 55035 Performance Criteria A
IEC 61000-4-8	Power Frequency Magnetic Field (PFMF)	Pass	For EN 55035 Performance Criteria A
IEC 61000-4-11	Voltage Dips and Interruptions (DIP)	Pass	For EN 55035 For Voltage Dips: <5% Residual, 0.5 cycle Performance Criteria A 70% Residual, 25 cycle Performance Criteria C For Voltage Interruptions: <5% Residual, 250 cycle Performance Criteria C

Note: Determining compliance based on the results of the compliance measurement, not taking into account measurement instrumentation uncertainty.

2.1 Performance Criteria

For EN 55035

General Performance Criteria

These criteria shall be used during the testing of primary functions where no specified in the normative annexes of EN 55035 is applicable.

Performance criterion A

The equipment shall continue to operate as intended without operator intervention. No degradation of performance, loss of function or change of operating state is allowed below a performance level specified by the manufacturer when the equipment is used as intended. The performance level may be replaced by a permissible loss of performance. If the minimum performance level or the permissible performance loss is not specified by the manufacturer, then either of these may be derived from the product description and documentation, and by what the user may reasonably expect from the equipment if used as intended.

Performance criterion B

During the application of the disturbance, degradation of performance is allowed. However, no unintended change of actual operating state or stored data is allowed to persist after the test.

After the test, the equipment shall continue to operate as intended without operator intervention; no degradation of performance or loss of function is allowed, below a performance level specified by the manufacturer, when the equipment is used as intended. The performance level may be replaced by a permissible loss of performance.

If the minimum performance level (or the permissible performance loss), or recovery time, is not specified by the manufacturer, then either of these may be derived from the product description and documentation, and by what the user may reasonably expect from the equipment if used as intended.

Performance criterion C

Loss of function is allowed, provided the function is self-recoverable, or can be restored by the operation of the controls by the user in accordance with the manufacturer's instructions. A reboot or re-start operation is allowed.

Information stored in non-volatile memory, or protected by a battery backup, shall not be lost.

Product Specific Performance criteria for Audio output functions

Performance criterion A

Table – Performance criterion A – Limits for devices supporting telephony

Type of immunity test	Frequency range MHz	Acoustic or electrical interference ratio	Equivalent direct measurement		
			dB(SPL)	Digital dBm0	Analogue dBm
Conducted	0.15 to 30	-20 dB	55	-50	-50
	30 to 80	-10 dB	65	-40	-40
Radiated	80 to 1 000	0 dB	75	-30	-30

The acoustic level of the demodulated audio shall be less than the limits in column 4.

For all other Audio output devices:

The measured acoustic interference ratio and/or the measured electrical interference ratio during the test shall be -20 dB or better.

Performance criterion B

Use the general performance criterion B.

Performance criterion C

Use the general performance criterion C.

Product Specific Performance criteria for network functions

Equipment that provides these functions transmits and receives data through ports such as an analogue/digital data port. The networking functions are just like network switching and routing ; data transmission ; supervisory...etc.

The particular performance criteria which are specified in the normative annexes of CISPR 35/ EN 55035 take precedence over the corresponding parts of the general performance criteria.

Performance criterion A

Where relevant, during the application of the test the network function shall, as a minimum, operate ensuring that:

- established connections shall be maintained throughout the application of the test;
- no change of operational state or corruption of stored data occurs;
- no increase in error rate above the figure defined by the manufacturer occurs. The manufacturer should select the most appropriate performance measurement criteria for the product or system, for example bit error rate, block error rate;
- no request for retry above the figure defined by the manufacturer;
- the data transmission rate does not reduce below the figure defined by the manufacturer;
- no protocol failure occurs;
- other verifications are described in F.3.3.1 of CISPR 35/ EN 55035.

Performance criterion B

Established connections shall be maintained throughout the test, or shall self-recover in a way and timescale that is imperceptible to the user.

The error rate, request for retry and data transmission rates may be degraded during the application of the test. Degradation of the performance as described in criterion A is permitted, provided that the normal operation of the EUT is self-recoverable to the condition established prior to the application of the test.

Where required, as defined in Clause 5 of CISPR 35/ EN 55035, the acceptable operation of the function shall be verified at the completion of the test as described in Table H.1 of CISPR 35/ EN 55035, by confirming the following:

- the EUT's ability to establish a connection,
- the EUT's ability to clear a connection.

During surge testing disconnection is allowed on the analogue/digital data port being tested.

If the EUT is a supervisory equipment, it shall not impact the normal operation of the network being monitored. In addition, any supervisory functions impacted during the period of the test shall return to the state prior to the test. Elements to consider include: alarms, signalling lamps, printer output, network traffic rates, network monitoring.

Performance criterion C

Degradation of performance as described in criteria A and B is permitted provided that the normal operation of the EUT is self-recoverable to the condition immediately before the application of the test, or can be restored after the test by the operator.

Product Specific Performance Criteria for xDSL

The particular performance criteria which are specified in the normative annexes of CISPR 35/ EN 55035 take precedence over the corresponding parts of the general performance criteria.

Performance criterion A

Applicable for the test requirement defined in table clause 2.1 of EN 55035

During the swept frequency test the established connection shall be maintained throughout the testing and the information transferred without any additional reproducible errors or loss of synchronisation. If a degradation in performance is observed and the system is adaptive, for example has the capability to automatically retrain in the presence of an interfering signal, then for conducted immunity tests only, the following procedure shall be followed:

- a) For each range of interfering frequencies in which degradation in performance is observed, three frequencies (beginning, middle and end) shall be identified.
- b) At each of the frequencies identified in step a), the interfering signal shall be turned on and the system is allowed to retrain.
- c) If the system is able to retrain and then functions correctly for a dwell time of at least 60 seconds without any additional reproducible errors or loss of synchronisation, then the performance level of the system is considered acceptable.
- d) The frequencies identified in step a) and the data rates achieved in step b) shall be recorded in the test report.

Applicable for the test requirement defined in table clause 2.2 of EN 55035

It is important that the modems are able to train in the presence of repetitive impulsive noise and minimize disruption to the end-user where a repetitive impulsive noise source starts after the link has synchronized. Therefore the following procedure and performance criteria shall apply.

The manufacturer shall select the class of impulsive noise protection (INP) to be used for the immunity test and should state this information in the technical documentation and in the test report. The maximum delay shall be set to 8 ms.

In the absence of impulsive noise: The modem shall operate without retraining at its target noise margin with a bit rate value depending on the line attenuation and the stationary noise being present on the line. (The actual value will be between the minimum and maximum bit rate values programmed in the port).

The impulsive noise source shall then be applied at the required test level.

With the impulsive noise applied: The modem shall operate without retraining and without SES at the bit rate established prior to the application of the impulsive noise. No extra CRC errors shall occur due to the impulsive noise.

After the test, the noise margin value shall return to the target noise margin.

Performance criterion B

Applicable for the test requirement defined in table clause 2.3 of EN 55035

Modems shall withstand the occurrence of isolated impulsive noise events. The performance criteria defined in below Table shall be applied.

Impulse duration (ms)	Performance criteria
0.24	The application of the impulse shall not cause the xDSL link to lose synchronisation. No CRC errors are permitted.
10	The application of the 5 impulses shall result in less than 75 CRC errors and shall not cause the link to lose synchronisation.
300	The application of the impulse shall not cause the xDSL link to lose synchronisation.

Applicable for the test requirements defined in table clauses 2.5 and 4.5 of EN 55035

For application of this test to the xDSL port, a repetition rate of 100 kHz (burst length 0.75 ms) shall be used.

Degradation of the performance as described in criterion A is permitted in that errors are acceptable during the application of the test. However the application of the test shall not cause the system to lose the established connection or re-train. At the cessation of the test the system shall operate in the condition established prior to the application of the test without user intervention.

After the application of the EFT/B tests to the xDSL or AC mains port, the CRC error count shall not have increased by more than 600 when compared to the count prior to the application of the test.

Performance criterion C

Degradation of the performance as described in criteria A and B is permitted provided that the normal operation of the EUT is self-recoverable to the condition established prior to application of the test or can be restored after the test by the operator.

2.2 Measurement Uncertainty

Where relevant, the following measurement uncertainty levels have been estimated for tests performed on the EUT as specified in CISPR 16-4-2:

Measurement	Specification	Expanded Uncertainty (k=2) (±)	Maximum allowable uncertainty (±)
Conducted Emissions from Power Ports	9 kHz ~ 30 MHz	2.9 dB	3.4 dB (U_{CISPR})
Conducted Emissions from Wired Network Ports	150 kHz ~ 30 MHz	ISN Cat3 : 3.0 dB ISN Cat5 : 3.0 dB ISN Cat6 : 3.0 dB Current Probe : 1.56 dB Voltage Probe : 2.90 dB Coaxial : 2.34 dB	5.0 dB (U_{CISPR}) using AAN 2.9 dB (U_{CISPR}) using CP 3.9 dB (U_{CISPR}) using CVP
Radiated Emissions up to 1 GHz	30 MHz ~ 1 GHz	3m: 5.32 dB 10m: 3.84 dB	6.3 dB (U_{CISPR})
Radiated Emissions above 1 GHz	1 GHz ~ 6 GHz	4.44 dB	5.2 dB (U_{CISPR})

The other instruments specified are routine verified to remain within the calibrated levels, no measurement uncertainty is required to be calculated.

2.3 Supplementary Information

There is not any deviation from the test standards for the test method, and no modifications required for compliance.

3 General Information

3.1 Description of EUT

Product	High-Performance Fanless System
Brand	Vecow
Test Model	IVX-1000-ICY
Series Model	IVX-1XXXXXXXXXXXXXXXXX ("X" can be 0-9, A-Z or blank for marketing purpose)
Model Difference	For Marketing Differentiation
Sample Status	Mass Production
Operating Software	WIN 10, BURNINTEST
Power Supply Rating	DC from Adapter
Accessory Device	Adapter
Data Cable Supplied	N/A

Note:

The EUT uses following adapter.

Brand	Model	Specification
LITEON	PA-1181-28E	AC Input: 100-240V, 2.34A, 50-60Hz (3pin) DC Output: 24V, 7.5A 180W (1.5m, with two ferrite cores.)

3.2 Primary Clock Frequencies of Internal Source

The highest frequency generated or used within the EUT or on which the EUT operates or tunes is 1.4 GHz, provided by Vecow Co., Ltd., for detailed internal source, please refer to the manufacturer's specifications.

3.3 Features of EUT

The tests reported herein were performed according to the method specified by Vecow Co., Ltd., for detailed feature description, please refer to the manufacturer's specifications or user's manual.

Please refer to appendix of the report if the applicant has provided additional descriptions of the EUT.

The EUT configured with the following key components:

Component	Specification
CPU	13th Gen Intel® Core™ i7-13700TE@1.10GHz
RAM	INNODISK DDR5 4800 32GB W/T SODIMM x 2
SSD	INNODISK 2.5" SATA SSD 3TE7 512GB x 6

3.4 Operating Modes of EUT and Determination of Worst Case Operating Mode

The EUT has been pre-tested under following test modes.

Test Condition	
Mode	Radiated Emissions up to 1 GHz
1	HDMI*2:1920*1080/60Hz + VGA:1920*1080/60Hz + with adapter + Lan 3 ~ Lan 10: with load & link + Lan 2:2.5G link + Lan 1:1G link + Input Power(230 Vac, 50 Hz)
Note: There are both standby mode and normal mode to be pre-tested then normal mode has the highest emission value.	

Test modes are presented in the report as below.

Test Condition	
Mode	Conducted Emissions from Power Ports
A	HDMI*2:1920*1080/60Hz + VGA:1920*1080/60Hz + with adapter + Lan 3~Lan 10: with load & link + Lan 2:2.5G link + Lan 1:1G link + Input Power(230 Vac, 50 Hz)
Mode	Conducted Emissions from Wired Network Ports
A	HDMI*2:1920*1080/60Hz + VGA:1920*1080/60Hz + with adapter + Lan 3~Lan 10:with load & link + Lan 2:2.5G link + for Lan 1:1Gbps link test + Input Power(230 Vac, 50 Hz)
B	HDMI*2:1920*1080/60Hz + VGA:1920*1080/60Hz + with adapter + Lan 3~Lan 10:with load & link + Lan 1:1G link + for Lan 2:2.5Gbps link test + Input Power(230 Vac, 50 Hz)
C	HDMI*2:1920*1080/60Hz + VGA:1920*1080/60Hz + with adapter + Lan 3~Lan 10:with load & link + Lan 2:2.5G link+Lan 1:1G link + for Lan 3:2.5Gbps link test + Input Power(230 Vac, 50 Hz)
D	HDMI*2:1920*1080/60Hz + VGA:1920*1080/60Hz + with adapter + Lan 3~Lan 10:with load & link + Lan 2:2.5G link+Lan 1:1G link + for Lan 10:2.5Gbps link test + Input Power(230 Vac, 50 Hz)
Note: The idle mode of conducted emission test at wired network ports test was pre-tested based on the worst case of link mode. Due to emissions of idle mode being very low compared to link mode, only the link mode data were presented in the test report.	
Mode	Radiated Emissions up to 1 GHz
A	HDMI*2:1920*1080/60Hz + VGA:1920*1080/60Hz + with adapter + Lan 3~Lan 10:with load & link + Lan 2:2.5G link + Lan 1:1G link + Input Power(230 Vac, 50 Hz)
Mode	Radiated Emissions above 1 GHz
A	HDMI*2:1920*1080/60Hz + VGA:1920*1080/60Hz + with adapter + Lan 3~Lan 10:with load & link + Lan 2:2.5G link + Lan 1:1G link + Input Power(230 Vac, 50 Hz)
Mode	Harmonic Current Measurement
A	HDMI*2:1920*1080/60Hz + VGA:1920*1080/60Hz + with adapter + Lan 3~Lan 10:with load & link + Lan 2:2.5G link + Lan 1:1G link + Input Power(230 Vac, 50 Hz)
Mode	Voltage Fluctuations and Flicker Measurement
A	HDMI*2:1920*1080/60Hz + VGA:1920*1080/60Hz + with adapter + Lan 3~Lan 10:with load & link + Lan 2:2.5G link + Lan 1:1G link + Input Power(230 Vac, 50 Hz)
Mode	Electrostatic Discharges (ESD)
A	HDMI*2:1920*1080/60Hz + VGA:1920*1080/60Hz + with adapter + Lan 3~Lan 10:with load & link + Lan 2:2.5G link + Lan 1:1G link + Input Power(230 Vac, 50 Hz)
Mode	Radio Frequency Electromagnetic Field (RS)
A	HDMI*2:1920*1080/60Hz + VGA:1920*1080/60Hz + with adapter + Lan 3~Lan 10:with load & link + Lan 2:2.5G link + Lan 1:1G link + Input Power(230 Vac, 50 Hz)
Mode	Fast Transients Common Mode (EFT)
A	HDMI*2:1920*1080/60Hz + VGA:1920*1080/60Hz + with adapter + Lan 3~Lan 10:with load & link + Lan 2:2.5G link + Lan 1:1G link + Input Power(230 Vac, 50 Hz)
Mode	Surges
A	HDMI*2:1920*1080/60Hz + VGA:1920*1080/60Hz + with adapter + Lan 3~Lan 10:with load & link + Lan 2:2.5G link + Lan 1:1G link + Input Power(230 Vac, 50 Hz)

Mode	Radio Frequency Common Mode (CS)
A	HDMI*2:1920*1080/60Hz + VGA:1920*1080/60Hz + with adapter + Lan 3~Lan 10:with load & link + Lan 2:2.5G link + Lan 1:1G link + Input Power(230 Vac, 50 Hz)
Mode	Power Frequency Magnetic Field (PFMF)
A	HDMI*2:1920*1080/60Hz + VGA:1920*1080/60Hz + with adapter + Lan 3~Lan 10:with load & link + Lan 2:2.5G link + Lan 1:1G link + Input Power(230 Vac, 50 Hz)
Mode	Voltage Dips and Interruptions (DIP)
A	HDMI*2:1920*1080/60Hz + VGA:1920*1080/60Hz + with adapter + Lan 3~Lan 10:with load & link + Lan 2:2.5G link + Lan 1:1G link + Input Power(230 Vac, 50 Hz)

3.5 Test Program Used and Operation Descriptions

For Emission test (Harmonics & Flicker excluded)

- Turned on the power of all equipment.
- EUT ran a test program (BurnIntest) to enable all functions.
- EUT read and wrote messages to/ from internal storage devices and external storage devices.
- Laptop/ PC (kept at remote area) sent and received messages to/ from EUT via LAN cable.
- EUT sent (ITU-R BT471-1) messages to monitors. Then they displayed messages on their screens simultaneously.
- EUT sent messages to printer and the printer printed them out.
- EUT sent (1kHz audio) signal to earphone
- Steps c-g were repeated.

For Harmonics, Flicker & Immunity test

- Turned on the power of all equipment.
- EUT ran a test program (BurnIntest) to enable all functions.
- EUT read and wrote messages to/ from internal storage devices and external storage devices.
- Laptop (kept at remote area) sent and received messages to/ from EUT via LAN cable.
- EUT sent (color bars with moving element) messages to monitor. Then they displayed messages on their screens simultaneously.
- EUT sent (1kHz audio) signal to earphone.
- Steps c-f were repeated.

3.6 Connection Diagram of EUT and Peripheral Devices

For Emission test (Harmonics & Flicker excluded)

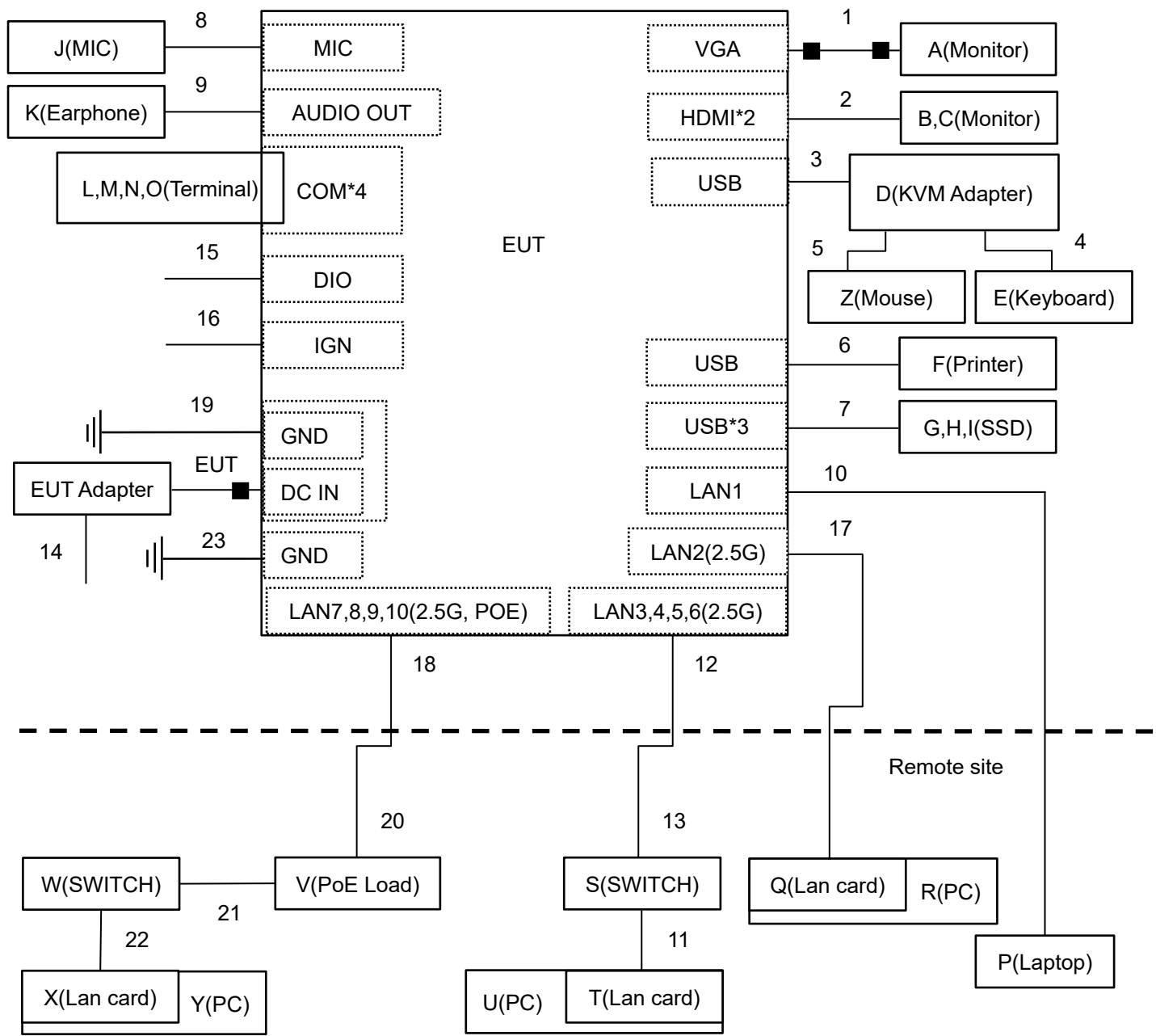

For Harmonics, Flicker & Immunity test

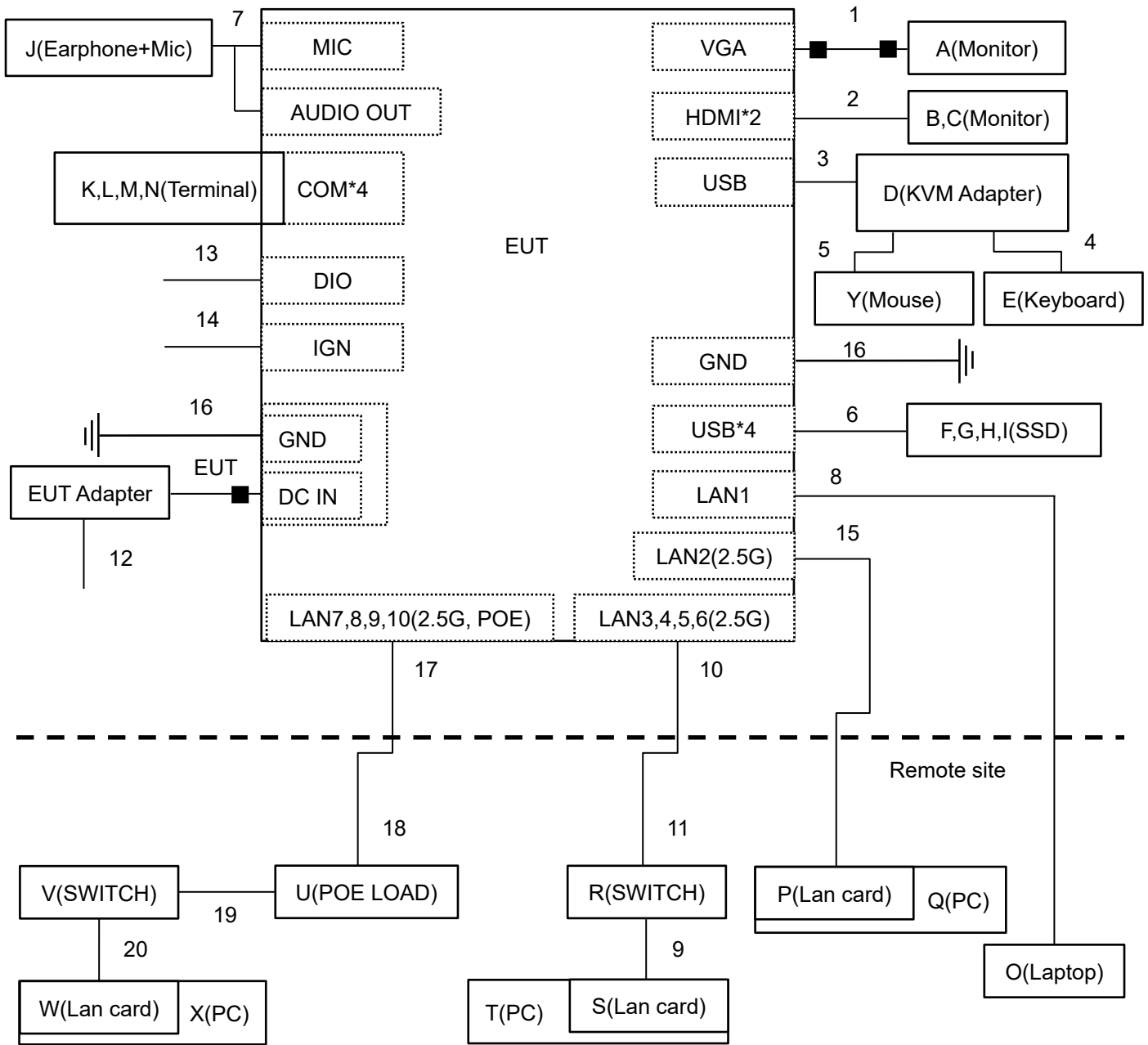

3.7 Configuration of Peripheral Devices and Cable Connections

For Emission test (Harmonics & Flicker excluded)

ID	Product	Brand	Model No.	Serial No.	FCC ID	Remarks
A	Monitor	DELL	U2410	CN082WXD728720CC0HLL	DoC	Provided by Lab
B	Monitor	DELL	U2410	CN082WXD728720CC0KVL	DoC	Provided by Lab
C	Monitor	DELL	U2410	CN082WXD728720CC0LGL	DoC	Provided by Lab
D	KVM Adapter	N/A	N/A	N/A	N/A	Supplied by applicant
E	USB Keyboard	Dell	KB216t	CN-0W33XP-LO300-7CL-1903	N/A	Provided by Lab
F	PRINTER	HP	HP Officejet Pro 251dw	CN62OCV0JN	B94SDGOB1191	Provided by Lab
G	USB 3.1 SSD	Crucial	CT500X8SSD9	1941E3201117	N/A	Provided by Lab
H	USB 3.1 SSD	Crucial	CT500X8SSD9	1940E3200AD3	N/A	Provided by Lab
I	USB 3.1 SSD	Crucial	CT500X8SSD9	1942E32014B5	N/A	Provided by Lab
J	Microphone	E-books	E-EPB099	N/A	N/A	Provided by Lab
K	EARPHONE	PHILIPS	SBC HL150	H2010150	N/A	Provided by Lab
L	Terminal	N/A	N/A	N/A	N/A	Supplied by applicant
M	Terminal	N/A	N/A	N/A	N/A	Supplied by applicant
N	Terminal	N/A	N/A	N/A	N/A	Supplied by applicant
O	Terminal	N/A	N/A	N/A	N/A	Supplied by applicant
P	Laptop	LENOVO	T480	PF1EZSA2	N/A	Provided by Lab
Q	LAN CARD_10G_PCl_e	ASUS	XG-C100C	N/A	DoC	Provided by Lab
R	PC	DELL	3010 SF	N/A	N/A	Provided by Lab
S	10G NETWORK SWITCH	NETGEAR	XS508M	52J22974D07E1	N/A	Provided by Lab
T	LAN CARD_10G_PCl_e	ASUS	XG-C100C	N/A	DoC	Provided by Lab
U	Desktop PC	DELL	3010 SF	CHWQS02	N/A	Provided by Lab
V	POE LOAD	N/A	N/A	N/A	N/A	Supplied by applicant
W	SWITCH	TP-LINK	TL-SX105	N/A	DoC	Provided by Lab
X	LAN CARD_10G_PCl_e	ASUS	XG-C100C	N/A	DoC	Provided by Lab
Y	PC	DELL	3010 SF	N/A	N/A	Provided by Lab
Z	USB Mouse	DELL	MOCZUL	CN-049TWY-PRC00-77B-0083	N/A	Provided by Lab



ID	Cable Descriptions	Qty.	Length (m)	Shielding (Yes/No)	Cores (Qty.)	Remarks
1	VGA cable	1	1.8	Yes	2	Provided by Lab
2	HDMI cable	2	2	Yes	0	Provided by Lab
3	USB cable	1	2	Yes	0	Supplied by applicant
4	USB cable	1	1.8	Yes	0	Provided by Lab
5	USB cable	1	1.8	Yes	0	Provided by Lab
6	USB cable	1	1.8	Yes	0	Provided by Lab
7	USB Type A to C cable	3	1	Yes	0	Provided by Lab
8	Audio cable	1	2	No	0	Provided by Lab
9	Audio cable	1	1.2	No	0	Provided by Lab
10	RJ45 (Cat. 5e) cable	1	10	Yes	0	Provided by Lab
11	RJ45 (Cat. 5e) cable	1	3	Yes	0	Provided by Lab
12	RJ45 (Cat. 5e) cable	4	2	Yes	0	Supplied by applicant
13	RJ45 (Cat. 5e) cable	4	10	Yes	0	Provided by Lab
14	AC power cable	1	1.8	No	0	Provided by Lab
15	Data cable	1	1.5	No	0	Provided by Lab
16	Data cable	1	1.5	No	0	Provided by Lab
17	RJ45 (Cat. 5e) cable	1	10	Yes	0	Provided by Lab
18	RJ45 (Cat. 5e) cable	4	2	Yes	0	Supplied by applicant
19	GND (PE) cable	1	2	No	0	Provided by Lab
20	RJ45 (Cat. 5e) cable	4	10	Yes	0	Provided by Lab
21	RJ45 (Cat. 5e) cable	4	3	Yes	0	Provided by Lab
22	RJ45 (Cat. 5e) cable	1	3	Yes	0	Provided by Lab
23	GND (PE) cable	1	1.5	No	0	Provided by Lab

For Harmonics, Flicker & Immunity test

ID	Product	Brand	Model No.	Serial No.	FCC ID	Remarks
A	Monitor	Vita	VT-270JTG2	204270JTFE002	DoC	Provided by Lab
B	Monitor	Vita	VT-270JTG2	204270JTFE001	DoC	Provided by Lab
C	Monitor	DELL	P2418HZM	CN-079XVV-TV200-8CP-071T	N/A	Provided by Lab
D	KVM Adapter	N/A	N/A	N/A	N/A	Supplied by applicant
E	USB Keyboard	LENOVO	KUF1256	N/A	N/A	Provided by Lab
F	USB 3.1 SSD	WD	WDBKVX5120PSL	1922MD400824	DoC	Provided by Lab
G	USB 3.1 SSD	WD	WDBKVX5120PSL	1922JG400125	DoC	Provided by Lab
H	USB 3.1 SSD	WD	WDBKVX5120PSL	1922JG400129	DoC	Provided by Lab
I	USB 3.1 External Hard Disk	WD	MY PASSPORT SSD	180887421404	N/A	Provided by Lab
J	Earphone+Mic	HP	H100	3H100210200191	N/A	Provided by Lab
K	Terminal	N/A	N/A	N/A	N/A	Supplied by applicant
L	Terminal	N/A	N/A	N/A	N/A	Supplied by applicant
M	Terminal	N/A	N/A	N/A	N/A	Supplied by applicant
N	Terminal	N/A	N/A	N/A	N/A	Supplied by applicant
O	Laptop	LENOVO	T480	PF1EZSA2	N/A	Provided by Lab
P	LAN CARD_10G_PCl_e	ASUS	XG-C100C	K5QSRT001881	DoC	Provided by Lab
Q	PC	DELL	3010 SF	1JWQS02	N/A	Provided by Lab
R	10G NETWORK SWITCH	NETGEAR	XS508M	52J23372D012B	N/A	Provided by Lab
S	LAN CARD_10G_PCl_e	ASUS	XG-C100C	K5QSRT001889	DoC	Provided by Lab
T	Desktop PC	DELL	3010 SF	CHWQS02	N/A	Provided by Lab
U	POE LOAD	N/A	N/A	N/A	N/A	Supplied by applicant
V	SWITCH	riverbed	XS-6024MP	N/A	N/A	Provided by Lab
W	LAN CARD_10G_PCl_e	ZYXEL	Marvell Aqtion	N/A	N/A	Provided by Lab
X	PC	Lenovo	M700	PC0C4QSY	N/A	Provided by Lab
Y	USB Mouse	LENOVO	MUEUUOA	N/A	N/A	Provided by Lab

ID	Cable Descriptions	Qty.	Length (m)	Shielding (Yes/No)	Cores (Qty.)	Remarks
1	VGA cable	1	1.8	Yes	2	Provided by Lab
2	HDMI cable	2	2	Yes	0	Provided by Lab
3	USB cable	1	2	Yes	0	Supplied by applicant
4	USB cable	1	1.8	Yes	0	Provided by Lab
5	USB cable	1	1.8	Yes	0	Provided by Lab
6	USB Type A to C cable	4	0.9	Yes	0	Provided by Lab
7	Audio cable	1	2	No	0	Provided by Lab
8	RJ45 (Cat. 5e) cable	1	10	Yes	0	Provided by Lab
9	RJ45 (Cat. 5e) cable	1	3	No	0	Provided by Lab
10	RJ45 (Cat. 5e) cable	4	2	Yes	0	Supplied by applicant
11	RJ45 (Cat. 5e) cable	4	10	Yes	0	Provided by Lab
12	AC power cable	1	1.8	No	0	Provided by Lab
13	Data cable	1	1.5	No	0	Provided by Lab
14	Data cable	1	1.5	No	0	Provided by Lab
15	RJ45 (Cat. 5e) cable	1	10	Yes	0	Provided by Lab
16	GND (PE) cable	2	3	No	0	Provided by Lab
17	RJ45 (Cat. 5e) cable	4	2	Yes	0	Supplied by applicant
18	RJ45 (Cat. 5e) cable	4	10	Yes	0	Provided by Lab
19	RJ45 (Cat. 5e) cable	4	3	Yes	0	Provided by Lab
20	RJ45 (Cat. 5e) cable	1	3	No	0	Provided by Lab

4 Test Instruments

The calibration interval of the all test instruments are 12 months and the calibrations are traceable to NML/ROC and NIST/USA.

4.1 Conducted Emissions from Power Ports

Description Manufacturer	Model No.	Serial No.	Calibrated Date	Calibrated Until
50 ohm terminal resistance LYNICS	0900510	E1-01-305	2024/2/6	2025/2/5
		E1-011285	2023/9/21	2024/9/20
		E1-011286	2023/9/21	2024/9/20
Coupling / Decoupling Network Schwarzbeck	CDNE-M2	00097	2024/5/28	2025/5/27
	CDNE-M3	00091	2024/5/28	2025/5/27
Coupling / Decoupling Network TESEQ	CDN A201A	44601	2023/12/14	2024/12/13
EMI Test Receiver R&S	ESCS 30	100276	2024/4/24	2025/4/23
	ESR3	102413	2024/1/29	2025/1/28
Fixed Attenuator EMEC	EM-ATT30002602NN	N/A	2024/3/22	2025/3/21
Fixed Attenuator STI	STI02-2200-10	NO.3	2023/10/20	2024/10/19
High Voltage Probe Schwarzbeck	TK9420	00982	2023/12/11	2024/12/10
LISN R&S	ENV216	101196	2024/5/22	2025/5/21
		101197	2023/7/12	2024/7/11
	ESH3-Z5	100220	2023/11/22	2024/11/21
LISN Schwarzbeck	NNLK 8121	8121-731	2024/6/12	2025/6/11
		8121-00759	2023/8/21	2024/8/20
	NNLK 8129	8129229	2024/6/14	2025/6/13
RF Coaxial Cable PEWC	5D-FB	Cable-CO3-01	2023/9/13	2024/9/12
Software BVADT	Cond_V7.4.1.0	N/A	N/A	N/A

Notes:

1. The test was performed in Linkou Conduction 3.
2. The VCCI Site Registration No. C-10274.
3. Tested Date: 2024/7/5

4.2 Conducted Emissions from Wired Network Ports

Description Manufacturer	Model No.	Serial No.	Calibrated Date	Calibrated Until
50 ohm terminal resistance LYNICS	0900510	E1-011285	2023/9/21	2024/9/20
		E1-011286	2023/9/21	2024/9/20
Capacitive Voltage Probe FCC	F-CVP-1	82	2023/8/24	2024/8/23
		94	2024/3/22	2025/3/21
Coupling / Decoupling Network TESEQ	CDN A201A	44601	2023/12/14	2024/12/13
EMI Test Receiver R&S	ESCS 30	100276	2024/4/24	2025/4/23
	ESR3	102413	2024/1/29	2025/1/28
Impedance Stabilization Network FCC	F-071115-1057-1	20651	2024/3/14	2025/3/13
		20652	2024/1/4	2025/1/3
Impedance Stabilization Network TESEQ	ISN S751	40599	2023/8/18	2024/8/17
	ISN ST08	41212	2023/8/31	2024/8/30
	ISN T8-Cat.6	53159	2024/6/18	2025/6/17
LISN R&S	ENV216	101196	2024/5/22	2025/5/21
		101197	2023/7/12	2024/7/11
		ESH3-Z5	100220	2023/11/22
LISN Schwarzbeck	NNLK 8121	8121-00759	2023/8/21	2024/8/20
Matching Pad EMCI	EMCI-3PDSM75BF	N/A	2023/12/13	2024/12/12
RF Coaxial Cable PEWC	5D-FB	Cable-CO3-01	2023/9/13	2024/9/12
RF Current Probe FCC	F-33-4	45	2024/6/15	2025/6/14
		56	2023/8/2	2024/8/1
Software BVADT	ISN_V7.4.1.0	N/A	N/A	N/A

Notes:

1. The test was performed in Linkou Conduction 3 (ISN 3).
2. The VCCI Site Registration No. T-11651.
3. Tested Date: 2024/7/5

4.3 Radiated Emissions up to 1 GHz

Description Manufacturer	Model No.	Serial No.	Calibrated Date	Calibrated Until
Bi_Log Antenna Schwarzbeck	VULB 9168	9168-316	2023/12/15	2024/12/14
		9168-317	2023/12/15	2024/12/14
Coupling / Decoupling Network Schwarzbeck	CDNE-M2	00097	2024/5/28	2025/5/27
	CDNE-M3	00091	2024/5/28	2025/5/27
EMI Test Receiver R&S	ESR3	102413	2024/1/29	2025/1/28
		102983	2024/5/23	2025/5/22
Fixed Attenuator Mini-Circuits	UNAT-5+	PAD-CH8-01	2023/9/22	2024/9/21
		PAD-CH8-02	2023/9/22	2024/9/21
Preamplifier EMCI	EMC9135	980326	2024/2/15	2025/2/14
		980711	2024/3/10	2025/3/9
RF Coaxial Cable JYBAO	LMR-600	Cable-CH8-01	2023/9/22	2024/9/21
		Cable-CH8-02	2023/9/22	2024/9/21
RF Coaxial Cable Pacific	8D-FB	Cable-CH8-03	2023/9/22	2024/9/21
Software BVADT	Radiated_V8.8.09	N/A	N/A	N/A
Tower Max Full.	MF7802	MF780208105	N/A	N/A
Turn Table & Tower Max Full.	MF7802	MF7802121	N/A	N/A

Notes:

1. The test was performed in Linkou 10M Chamber (Chamber 8) , The test site validated date: 2023/8/26 (NSA)
2. The VCCI Site Registration No. R-12946.
3. Tested Date: 2024/7/5

4.4 Radiated Emissions above 1 GHz

Description Manufacturer	Model No.	Serial No.	Calibrated Date	Calibrated Until
Fix tool for Boresight antenna tower BV	BAF-01	9	N/A	N/A
Fixed Attenuator Mini-Circuits	BW-K3-2W44+	PAD-CH7-03	2024/7/5	2025/7/4
	BW-N4W5+	PAD-CH10-02	2024/7/5	2025/7/4
Horn Antenna EMCO	3115	6714	2023/11/12	2024/11/11
Horn Antenna ETS-Lindgren	3117-PA	00215857	2023/11/12	2024/11/11
Horn Antenna Schwarzbeck	BBHA-9170	BBHA9170190	2023/11/12	2024/11/11
MXA Signal Analyzer Keysight	N9020B	MY60110438	2023/11/28	2024/11/27
		MY60112260	2024/5/29	2025/5/28
Notch Filter Micro-Tronics	BRC50703-01	010	2024/5/24	2025/5/23
	BRM17690	005	2024/5/24	2025/5/23
Preamplifier EMCI	EMC0126545	980076	2024/2/15	2025/2/14
	EMC184045B	980235	2024/2/15	2025/2/14
Preamplifier HP	8449B	3008A01292	2024/2/15	2025/2/14
RF Coaxial Cable EMCI	EMC102-KM-KM-1000	200310	2024/7/5	2025/7/4
	EMC102-KM-KM-3000	200312	2024/7/5	2025/7/4
Software BVADT	Radiated_V8.8.09	N/A	N/A	N/A
Turn Table & Tower Max Full	MF7802	MF780208216	N/A	N/A

Notes:

1. The test was performed in Linkou 966 Chamber 3 (CH 10).
2. The VCCI Site Registration No. G-10427.
3. Tested Date: 2024/7/6

4.5 Harmonic Current Measurement

Description Manufacturer	Model No.	Serial No.	Calibrated Date	Calibrated Until
Harmonics and Flicker TESEQ	NSG1007 / NSG2196 / NSG2197	1323A03998	2023/11/27	2024/11/26
Software	CTS MXH	N/A	N/A	N/A

Notes:

1. The test was performed in Linkou EMS Room No.02.
2. Tested Date: 2023/12/18

4.6 Voltage Fluctuations and Flicker Measurement

Refer to section 4.5 to get the tested date and information of the instruments.

4.7 Electrostatic Discharges (ESD)

Description Manufacturer	Model No.	Serial No.	Calibrated Date	Calibrated Until
Electronic Discharge Simulator Noiseken	ESS-2000	ESS0382041	2023/10/13	2024/10/12
Electrostatic Analog Tester TESEQ	NSG 438	1875	2023/11/10	2024/11/9
ESD Generator EM TEST	Dito	V0701102114	2023/11/7	2024/11/6
	Dito//DM-150/330//DM- 150/330-rfci	P1315117252/P1317117852	2023/7/6	2024/7/5
ESD Simulator TESEQ	NSG 438	1364	2023/11/10	2024/11/9

Notes:

1. The test was performed in Linkou ESD Room No.01.
2. Tested Date: 2024/5/6

4.8 Radio Frequency Electromagnetic Field (RS)

Description Manufacturer	Model No.	Serial No.	Calibrated Date	Calibrated Until
Audio analyzer R&S	UPV	104934	2023/8/7	2024/8/6
Band Pass Filter B&K	WH3278	N/A	2023/11/20	2024/11/19
CHANCE MOST Full Anechoic Chamber (9x5x3m)	Chance Most	RS-002	2024/1/22	2025/1/21
Controller Amplifier Research	SC1000M3	305910	N/A	N/A
High Gain Horn Antenna Amplifier Research	AT4010	0329800	N/A	N/A
Isotropic EM Field Probe+EM Field Meter Wavecontrol	WPF18+SMP2	21WP090492+21SN1691	2023/12/14	2024/12/13
Log Periodic Antenna Amplifier Research	AT6080	0329465	N/A	N/A
Power Amplifier Amplifier Research	35S4G8AM4	0326094	N/A	N/A
Power Amplifier BONN	BSA 0125-800	1912556	N/A	N/A
Power Sensor Boonton	51011-EMC	32807	2023/5/31	2024/5/30
		32832	2023/5/31	2024/5/30
Pressure-field Microphone B&K	4192	3190854	2023/12/12	2024/12/11
		3190855	2023/12/12	2024/12/11
PSG Analog Signal Generator Agilent	E8257D	MY48050465	2023/6/26	2024/6/25
RF Power Amplifier BONN	BLMA 1060-150	2214325C-02	N/A	N/A
	BLWA 0810-250	2214325A-01	N/A	N/A
RF Power Meter Boonton	4232A	94901	2023/5/31	2024/5/30
Software BVADT	ABMS_Audio V7.4.10	N/A	N/A	N/A
Software BVADT	RS_V7.6.14	N/A	N/A	N/A
Stacked Log Periodic Antenna Schwarzbeck	STLP 9149	9149-260	N/A	N/A
Two channel microphone conditioning amplifier B&K	2690-OS2	3001996	2023/11/20	2024/11/19
Wideband Radio Communication Tester R&S	CMW500	170333	2023/12/6	2024/12/5

Notes:

1. The test was performed in Linkou RS Room No.02.
2. Tested Date: 2024/5/21

4.9 Fast Transients Common Mode (EFT)

Description Manufacturer	Model No.	Serial No.	Calibrated Date	Calibrated Until
Capacitive Coupling clamp EMC PARTNER	CN-EFT1000	352	2024/4/15	2025/4/14
Surge & EFT Generators TESEQ	NSG 3060	1572	2024/4/15	2025/4/14

Notes:

1. The test was performed in Linkou EMS Room No.02.
2. Tested Date: 2024/5/22

4.10 Surges

Description Manufacturer	Model No.	Serial No.	Calibrated Date	Calibrated Until
CDN for Unshielded Unsymmetrical Signal & Data Lines TESEQ	CDN117	40144	2023/8/29	2024/8/28
Coupling / Decoupling Network TESEQ	CDN 118-T8	40386	2023/8/28	2024/8/27
	CDN HSS-2	41009	2023/4/18	2024/4/17
Surge & EFT Generators TESEQ	NSG 3060	1572	2023/4/18	2024/4/17

Notes:

1. The test was performed in Linkou EMS Room No.02.
2. Tested Date: 2023/12/18

4.11 Radio Frequency Common Mode (CS)

Description Manufacturer	Model No.	Serial No.	Calibrated Date	Calibrated Until
Audio analyzer R&S	UPV	104934	2023/8/7	2024/8/6
Band Pass Filter B&K	WH3278	N/A	2023/6/8	2024/6/7
CDN Calibration Kit TESEQ	CDN T8S	29459	2024/2/19	2025/2/18
Coupling / Decoupling Network EM TEST	CDN M1/32A	306508	2024/2/19	2025/2/18
Coupling / Decoupling Network FCC	FCC-801-M2-16A	01047	2024/2/19	2025/2/18
	FCC-801-M5-50A	100018	2024/1/16	2025/1/15
Coupling / Decoupling Network TESEQ	CDN M232	37702	2024/2/19	2025/2/18
	CDN M332	41256	2024/2/19	2025/2/18
		41258	2024/2/19	2025/2/18
	CDN M432S	56519	2024/2/19	2025/2/18
	CDN S200	53490	2024/2/19	2025/2/18
	CDN S400	52115	2024/2/19	2025/2/18
	CDN S751A	56435	2024/2/19	2025/2/18
		56436	2024/2/19	2025/2/18
	CDN ST08A	56525	2024/2/19	2025/2/18
		56527	2024/2/19	2025/2/18
CDN T2A-10	54942	2024/2/19	2025/2/18	



Description Manufacturer	Model No.	Serial No.	Calibrated Date	Calibrated Until
	CDN T8-10	40376	2024/2/19	2025/2/18
	CDN T8-230	56641	2023/9/28	2024/9/27
		56642	2023/9/28	2024/9/27
	CDN T400A	49918	2024/2/19	2025/2/18
	CDN T800	34428	2024/2/19	2025/2/18
Current Clamp FCC	F-120-9A	361	2023/8/23	2024/8/22
FCC EM Injection Clamp FCC	F-203I-23mm	455	N/A	N/A
Fixed Attenuator SGH	VFA_Z-06H20-N2-06	01	N/A	N/A
Power Amplifier BONN	BSA 0125-125	2314648	N/A	N/A
Power Sensor R&S	NRV-Z5	837878/039	2023/10/16	2024/10/15
Pressure-field Microphone B&K	4192	3190854	2023/12/12	2024/12/11
		3190855	2023/12/12	2024/12/11
RF Power Meter R&S	NRVD	837794/040	2023/10/16	2024/10/15
Signal Generator R&S	SML03	101364	2023/8/16	2024/8/15
Software BVADT	ABMS_Audio V7.4.10	N/A	N/A	N/A
Software BVADT	BVADT_CS_V7.6.6	N/A	N/A	N/A
Two channel microphone conditioning amplifier B&K	2690-OS2	2645274	2023/6/8	2024/6/7
Wideband Radio Communication Tester R&S	CMW500	170333	2023/12/6	2024/12/5

Notes:

1. The test was performed in Linkou CS Room No.1.
2. Tested Date: 2024/5/22

4.12 Power Frequency Magnetic Field (PFMF)

Description Manufacturer	Model No.	Serial No.	Calibrated Date	Calibrated Until
Magnetic Field Meter Combinova	MFM 10	224	2023/10/12	2024/10/11
Magnetic Field Test System Haefely Trench AG	MAG 100	083794-06	N/A	N/A

Notes:

1. The test was performed in Linkou EMS Room No.1.
2. Tested Date: 2023/12/18

4.13 Voltage Dips and Interruptions (DIP)

Description Manufacturer	Model No.	Serial No.	Calibrated Date	Calibrated Until
Harmonics and Flicker TESEQ	NSG1007 / NSG2196 / NSG2197	1323A03998	2023/11/27	2024/11/26
Software	WIN2120	N/A	N/A	N/A

Notes:

1. The test was performed in Linkou EMS Room No.02.
2. Tested Date: 2023/12/18

5 Limits of Test Items

5.1 Conducted Emissions from Power Ports

Frequency (MHz)	Class A (dB μ V)		Class B (dB μ V)	
	Quasi-peak	Average	Quasi-peak	Average
0.15 - 0.5	79	66	66 - 56	56 - 46
0.50 - 5.0	73	60	56	46
5.0 - 30.0	73	60	60	50

- Notes: 1. The lower limit shall apply at the transition frequencies.
 2. The limit decreases linearly with the logarithm of the frequency in the range of 0.15 to 0.50 MHz.

5.2 Conducted Emissions from Wired Network Ports

Frequency (MHz)	Coupling Device	Class A				Class B			
		Voltage Limit (dB μ V)		Current limits (dB μ A)		Voltage Limit (dB μ V)		Current limits (dB μ A)	
		Quasi-peak	Average	Quasi-peak	Average	Quasi-peak	Average	Quasi-peak	Average
0.15-0.5	AAN	97-87	84-74	-	-	84-74	74-64	-	-
0.5-30		87	74	-	-	74	64	-	-
0.15-0.5	CVP and Current probe	97-87	84-74	53-43	40-30	84-74	74-64	40-30	30-20
0.5-30		87	74	43	30	74	64	30	20
0.15-0.5	Current Probe	-	-	53-43	40-30	-	-	40-30	30-20
0.5-30		-	-	43	30	-	-	30	20

Note: The limits decrease linearly with the logarithm of the frequency in the range 0.15 MHz to 0.5 MHz.

5.3 Radiated Emissions up to 1 GHz

Frequency (MHz)	Class A Quasi-peak (dB μ V/m)		Class B Quasi-peak (dB μ V/m)	
	at 3m	at 10m	at 3m	at 10m
30 - 230	50	40	40	30
230 - 1000	57	47	47	37

For radiated emissions from FM receivers only (Measurement Facility: OATS/SAC)

Frequency (MHz)	Fundamental (dB μ V/m)		Harmonics (dB μ V/m)	
	at 3m	at 10m	at 3m	at 10m
30 - 230	60	50	52	42
230 - 300	60	50	52	42
300 - 1000	60	50	56	46

- Notes: 1. The lower limit shall apply at the transition frequencies.
 2. Emission level (dB μ V/m) = 20 log Emission level (μ V/m).
 3. All emanations from a class A/B digital device or system, including any network of conductors and apparatus connected thereto, shall not exceed the level of field strengths specified above.

5.4 Radiated Emissions above 1 GHz

Frequency (GHz)	Class A (dBuV/m) (at 3m)		Class B (dBuV/m) (at 3m)	
	Average	Peak	Average	Peak
1 to 3	56	76	50	70
3 to 6	60	80	54	74

- Notes: 1. The lower limit shall apply at the transition frequencies.
 2. Emission level (dBuV/m) = 20 log Emission level (uV/m).
 3. All emanations from a class A/B digital device or system, including any network of conductors and apparatus connected thereto, shall not exceed the level of field strengths specified above.

Frequency Range of Radiated Measurement (For unintentional radiators)

Highest internal frequency (F_x)	Highest measurement frequency (F_M) (GHz)
$F_x \leq 108 \text{ MHz}$	1
$108 \text{ MHz} < F_x \leq 500 \text{ MHz}$	2
$500 \text{ MHz} < F_x \leq 1 \text{ GHz}$	5
$F_x > 1 \text{ GHz}$	$5 \times F_x$ up to a maximum of 6 GHz

F_x is the highest fundamental frequency generated and/or used in the ITE or digital apparatus under test.

5.5 Harmonic Current Measurement

Limits for Class A equipment		Limits for Class D equipment		
Harmonic Order n	Max. permissible harmonics current A	Harmonic Order n	Max. permissible harmonics current per watt mA/W	Max. permissible harmonics current A
Odd harmonics		Odd Harmonics only		
3	2.30	3	3.4	2.30
5	1.14	5	1.9	1.14
7	0.77	7	1.0	0.77
9	0.40	9	0.5	0.40
11	0.33	11	0.35	0.33
13	0.21	13	0.30	0.21
$15 \leq n \leq 39$	$0.15 \times 15/n$	$15 \leq n \leq 39$	$3.85/n$	$0.15 \times 15/n$
Even harmonics				
2	1.08			
4	0.43			
6	0.30			
$8 \leq n \leq 40$	$0.23 \times 8/n$			

- Notes: 1. Class A and Class D are classified according to section 5 of EN 61000-3-2.
 2. According to section 7 of EN 61000-3-2, the above limits for all equipment except for lighting equipment having an active input power > 75 W and no limits apply for equipment with an active input power up to and including 75 W.

Classification of equipment

Class A	Class B	Class C	Class D
Balanced three-phase equipment; Household appliances excluding equipment as Class D; Tools excluding portable tools; Dimmers for incandescent lamps; Audio equipment; Equipment not specified in one of the three other classes.	Portable tools; Arc welding equipment which is not professional equipment.	Lighting equipment.	Equipment having a specified power less than or equal to 600 W of the following types: Personal computers and personal computer monitors; Television receivers; Refrigerators and freezers having one or more variable-speed drives to control compressor motor(s).

5.6 Voltage Fluctuations and Flicker Measurement

Test Item	Limit	Note
P_{st}	1.0	P_{st} means short-term flicker indicator.
P_{lt}	0.65	P_{lt} means long-term flicker indicator.
T_{dt} (ms)	500	T_{dt} means maximum time that $d(t)$ exceeds 3.3 %.
d_c (%)	3.3%	d_c means relative steady-state voltage change d_{max} means maximum relative voltage change. Control Method of Equipment (see below)
d_{max} (%)	4%	<input checked="" type="checkbox"/> - without additional conditions
	6%	<input type="checkbox"/> - switched manually, or - switched automatically more frequently than twice per day, and also has either a delayed restart (the delay not less than a few tens of seconds), or manual restart, after a power supply interruption
	7%	<input type="checkbox"/> - attended whilst in use (for example: hair dryers, vacuum cleaners, kitchen equipment such as mixers, garden equipment such as lawn mowers, portable tools such as electric drills), or switched on automatically, or - is intended to be switched on manually, no more than twice per day, and also has either a delayed restart (the delay being not less than a few tens of seconds) or manual restart, after a power supply interruption.

5.7 General immunity requirements

For EN 55035

Port	Basic Standard	Test item	Test specification	Performance criteria	
Power input (AC)	IEC 61000-4-4	Fast Transients, Common Mode (EFT)	±1 kV 5/50 ns (Tr/Th) 5 kHz, repetition frequency	B	
	IEC 61000-4-5	Surge	Line to line: ±1 kV, 1.2/50 µs Line to earth: ±2 kV, 1.2/50 µs	B	
	IEC 61000-4-6	Radio Frequency, Common Mode (CS)	0.15-10 MHz, 3 V, 80% AM (1 kHz), 10-30 MHz, 3 V-1 V, 80% AM (1 kHz), 30-80 MHz, 1 V, 80% AM (1 kHz),	A	
	IEC 61000-4-11	Voltage dips and interruptions (DIP)	Voltage Dips: < 5% residual voltage, 0.5 cycle 70% residual voltage, 25 cycles (at 50 Hz) Voltage Interruption: < 5% residual voltage, 250 cycles (at 50 Hz)	B C C	
DC power/ Wired network and Signal/ Control port	IEC 61000-4-4	Fast Transients, Common Mode (EFT)	±0.5 kV 5/50 ns (Tr/Th) 100 kHz, repetition frequency for xDSL port 5 kHz, repetition frequency for other port	B	
	IEC 61000-4-5	Surge	Wired network ports (directly connected to outdoor cables): Symmetrically operated: 10/700 µs w/o primary protectors: ±1.0 kV, or with primary protectors fitted: ±1.0 kV and ±4.0 kV, Coaxial or shielded operated: 1.2/50 µs shield to ground: ±0.5 kV,	C B	
			DC power ports (directly connected to outdoor cables): 1.2/50 µs each individual line to earth, or shield to ground: ±0.5 kV,	B	
	IEC 61000-4-6	Broadband impulse noise disturbances (Applicable only to xDSL ports.)	Radio Frequency, Common Mode (CS)	0.15-10 MHz, 3 V, 80% AM (1 kHz), 10-30 MHz, 3 V-1 V, 80% AM (1 kHz), 30-80 MHz, 1 V, 80% AM (1 kHz),	A
			Repetitive : Impulse frequency profile : 0.15 – 0.5 MHz, 107 dBuV ; 0.5 – 10 MHz, 107 – 36 dBuV ; 10 – 30 MHz, 36 – 30 dBuV Burst duration : 0.70 ms Burst period : 10 ms (for 50 Hz) At least 2 minutes for each port under test.	A	
Isolated : Impulse frequency profile : 0.15 – 30 MHz, 110 dBuV Burst duration : 0.24 ms, 10 ms and 300 ms Isolated impulses : 5 times Interval : at least 60 seconds			B		

Port	Basic Standard	Test item	Test specification	Performance criteria
Enclosure	IEC 61000-4-2	Electrostatic Discharge (ESD)	±4 kV (contact) ±8 kV (Air)	B
	IEC 61000-4-3	Radio Frequency Electromagnetic Field (RS)	Swept Frequency Test: 80 to 1000(MHz), 3 V/m, 80% AM (1 kHz) Spot Frequency Test: 1800, 2600, 3500, 5000 MHz (±1%), 3 V/m, 80% AM (1 kHz)	A
	IEC 61000-4-8	Power Frequency Magnetic Field (PFMF)	1 A/m, 50 Hz	A

6 Test Arrangements

6.1 Conducted Emissions from Power Ports

- a. The EUT is placed 0.4 meters from the conducting wall of the shielded room with EUT being connected to the power mains through a line impedance stabilization network (LISN), or an Artificial Network (AN) as specified in CISPR 25 if uses in a vehicle. Other support units are connected to the power mains through another LISN and/or AN. They provide coupling impedance for the measuring instrument.
- b. Both lines of the power mains connected to the EUT were checked for maximum conducted interference.
- c. The test results of conducted emissions at mains ports are recorded of six worst margins for quasi-peak (mandatory) [and average (if necessary)] values against the limits at frequencies of interest unless the margin is 20 dB or greater.

Note: The resolution bandwidth and video bandwidth of test receiver is 9kHz for quasi-peak detection (QP) and average detection (AV) at frequency 0.15MHz-30MHz.

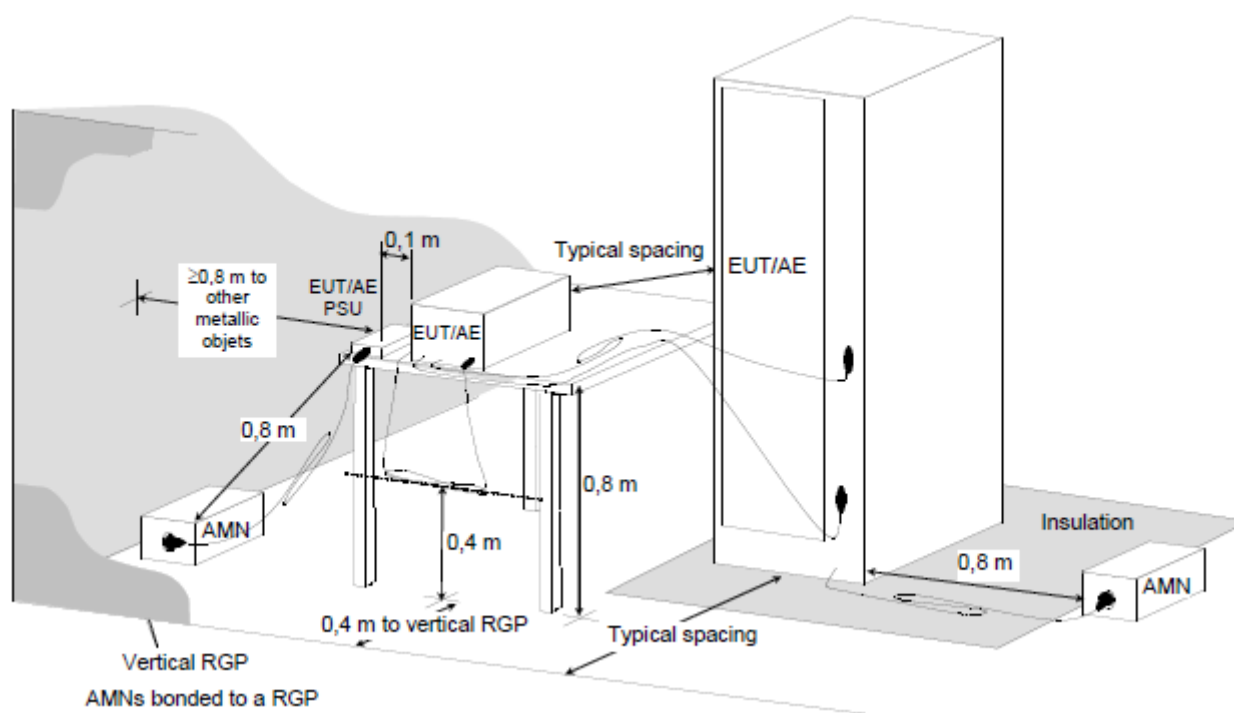

For the actual test configuration, please refer to the related Item – Photographs of the Test Configuration.

6.2 Conducted Emissions from Wired Network Ports

Method of Using AANs:

- The EUT is placed 0.4 meters from the conducting wall of the shielded room and connected to AAN directly to reference ground plane.
- If voltage measurement is used, measure voltage at the measurement port of the AAN, correct the reading by adding the AAN voltage division factor, and compare to the voltage limit.
- It is not necessary to apply the current limit if a AAN is used.
- The test results of disturbance at telecommunication ports are recorded of six worst margins for quasi-peak (mandatory) [and average (if necessary)] values against the limits at frequencies of interest unless the margin is 20 dB or greater.

Note: The resolution bandwidth and video bandwidth of test receiver is 9kHz for quasi-peak detection (QP) and average detection (AV) at frequency 0.15MHz-30MHz.

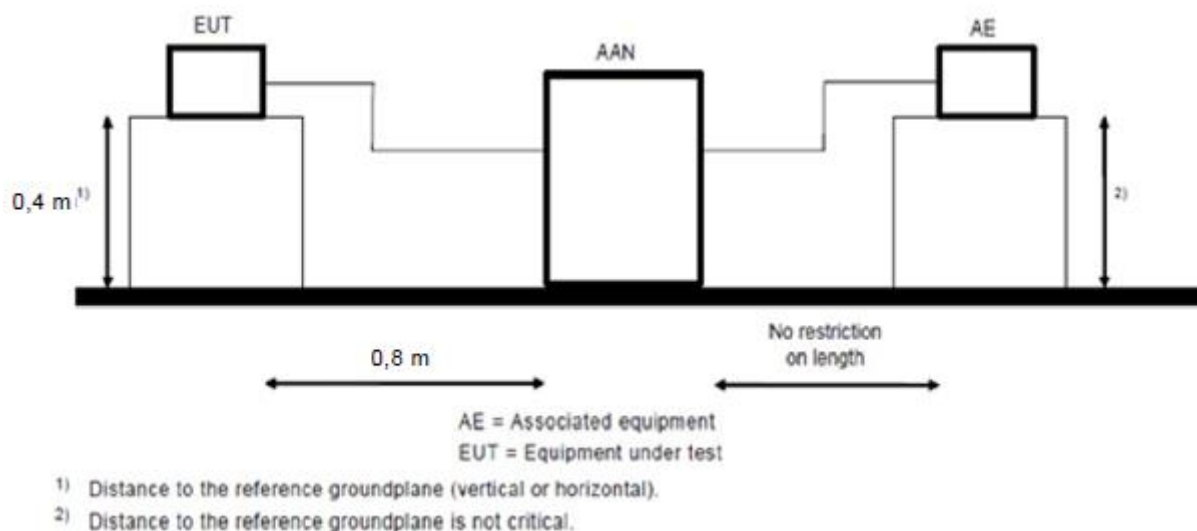

For the actual test configuration, please refer to the related Item – Photographs of the Test Configuration.

Method of Using a combination of Current Probe and 150 Ω load to the outside surface of the shielding cable:

- Breaks the external protective insulation (exposing the shield) and connect a 150Ω resistor from the outside surface of the shield to ground.
- A current probe shall be placed at 0.1 m from the 150Ω resistor. The current probe to EUT horizontal distance is between 0.3 m to 0.8 m.
- If current measurement is used, measure current at the measurement port of the current probe, correct the reading by adding the current probe division factor, and compare to the current limit.
- It is not necessary to apply the voltage limit if a current probe is used.
- The test results of disturbance at telecommunication ports are recorded of six worst margins for quasi-peak (mandatory) [and average (if necessary)] values against the limits at frequencies of interest unless the margin is 20 dB or greater.

Note: The resolution bandwidth and video bandwidth of test receiver is 9kHz for quasi-peak detection (QP) and average detection (AV) at frequency 0.15MHz-30MHz.

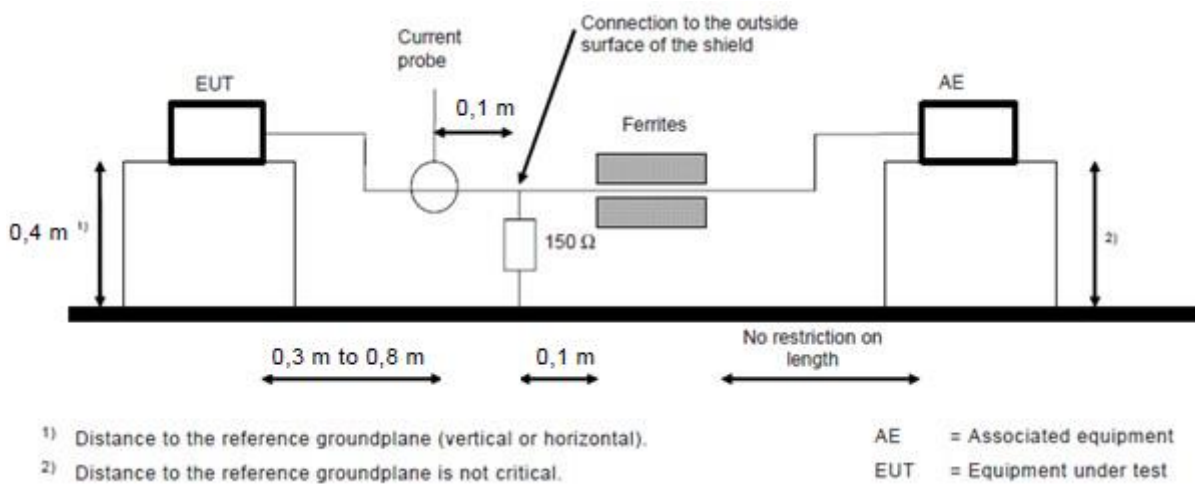

For the actual test configuration, please refer to the related Item – Photographs of the Test Configuration.

Method of Using a combination of current probe and capacitive voltage probe:

- a. Measure current with a current probe.
- b. Compare the measured current with the applicable current limit.
- c. Measure voltage with a capacitive voltage probe as specified in 5.2.2 of CISPR 16-1-2.
- d. Adjust the measured voltage as follows:
 - current margin ≤ 6 dB – subtract the actual current margin from measured voltage;
 - current margin > 6 dB – subtract 6 dB from measured voltage.
- e. Compare adjusted voltage with the applicable voltage limit
- f. Both the measured current and the adjusted voltage shall be below the applicable
- g. The test results of disturbance at telecommunication ports are recorded of six worst margins for quasi-peak (mandatory) [and average (if necessary)] values against the limits at frequencies of interest unless the margin is 20 dB or greater.

Note: The resolution bandwidth and video bandwidth of test receiver is 9kHz for quasi-peak detection (QP) and average detection (AV) at frequency 0.15MHz-30MHz.

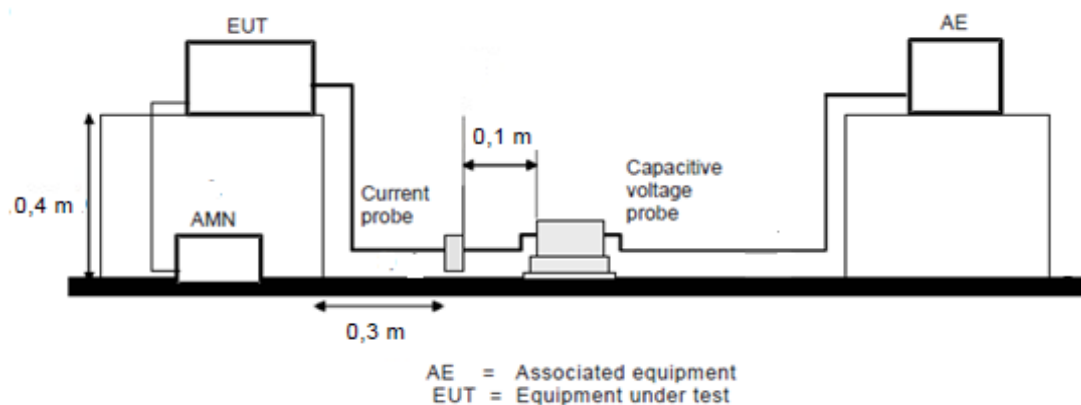

For the actual test configuration, please refer to the related Item – Photographs of the Test Configuration.

6.3 Radiated Emissions up to 1 GHz

- For the table-top EUT is placed on a 0.8 meter to the top of rotating table; for the floor standing EUT shall be insulated (by insulation of maximum thickness of 150 mm) from the horizontal reference ground plane. The rotating table is rotated 360 degrees to determine the position of the highest radiation. If the equipment requires a dedicated ground connection, this shall be provided and bonded to the RGP.
- The EUT is set 10 meters away from the interference-receiving antenna, which is mounted on the top of a variable-height antenna tower.
- The antenna is a broadband antenna, and its height is varied from one meter to four meters above the ground to determine the maximum value of the field strength. Both horizontal and vertical polarizations of the antenna are set to make the measurement.
- For each suspected emission, the EUT is arranged to its worst case and then the antenna is tuned to heights from 1 m to 4 m and the rotatable table was turned from 0 degrees to 360 degrees to find the maximum reading.
- The test-receiver system is set to quasi-peak detect function and specified bandwidth with maximum hold mode when the test frequency is up to 1 GHz.

Note: The resolution bandwidth and video bandwidth of test receiver/spectrum analyzer is 120kHz for quasi-peak detection (QP) at frequency up to 1GHz.

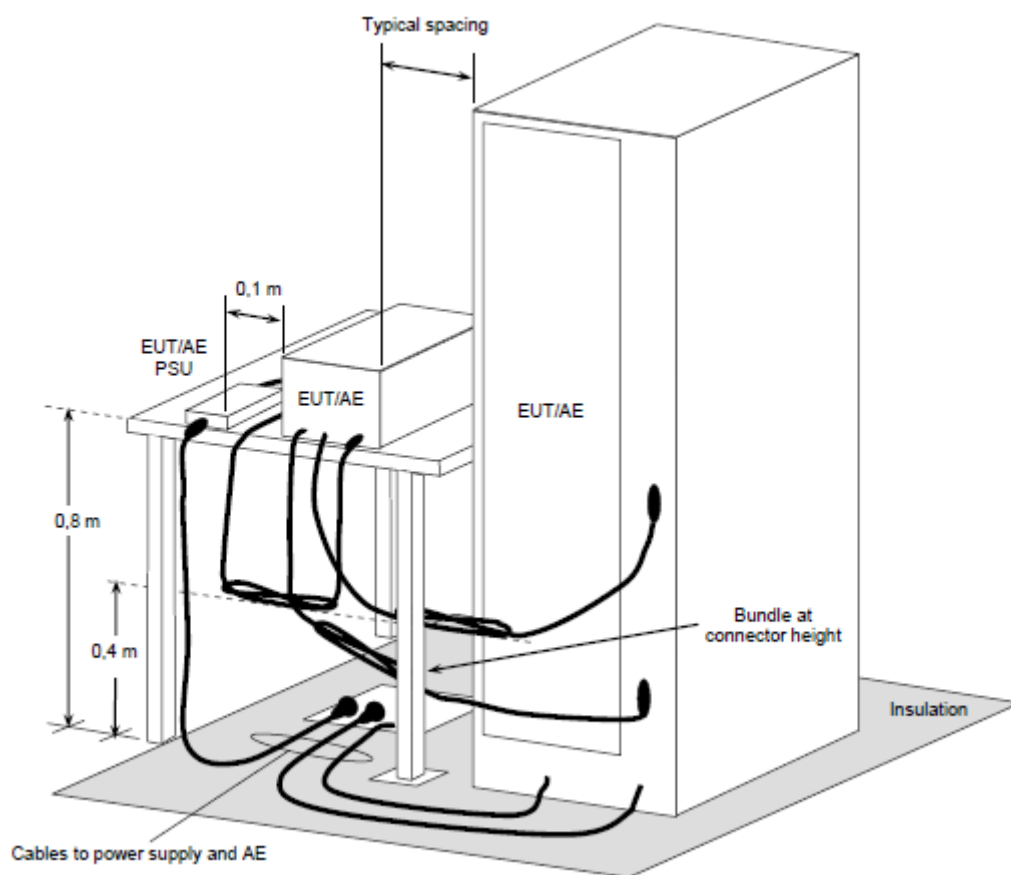

For the actual test configuration, please refer to the related Item – Photographs of the Test Configuration.

6.4 Radiated Emissions above 1 GHz

- For the table-top EUT is placed on a 0.8 meter to the top of rotating table; for the floor standing EUT shall be insulated (by insulation of maximum thickness of 150 mm) from the horizontal reference ground plane. The rotating table is rotated 360 degrees to determine the position of the highest radiation. If the equipment requires a dedicated ground connection, this shall be provided and bonded to the RGP.
- The EUT was set $d = 3$ meters away from the interference-receiving antenna, which was mounted on the top of a variable-height antenna tower.
- The height of antenna can be varied from one meter to four meters, the height of adjustment depends on the EUT height and the antenna 3dB beamwidth both, to detect the maximum value of the field strength. Both horizontal and vertical polarizations of the antenna are set to make the measurement.
- For each suspected emission, the EUT was arranged to its worst case and then the antenna was tuned to heights and the rotatable table was turned from 0 degrees to 360 degrees to find the maximum reading.
- The spectrum analyzer system was set to peak and average detects function and specified bandwidth with maximum hold mode when the test frequency is above 1 GHz.

Note: The resolution bandwidth of test receiver/spectrum analyzer is 1MHz and video bandwidth is 3MHz for Peak detection (PK) at frequency above 1GHz. The resolution bandwidth of test receiver/spectrum analyzer is 1 MHz for Average detection (AV) at frequency above 1GHz.

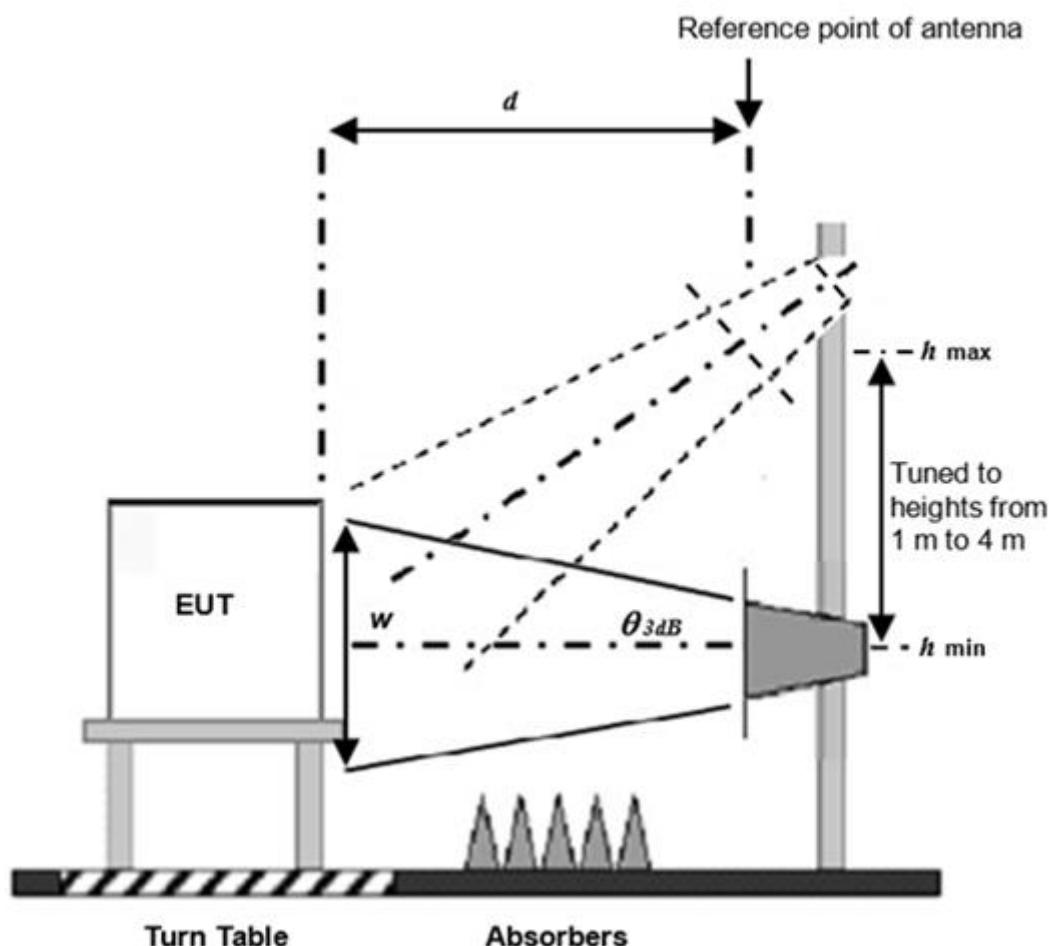

For the actual test configuration, please refer to the related item – Photographs of the Test Configuration.

6.5 Harmonic Current Measurement

- The harmonic current limits apply to line currents and not to currents in the neutral conductor. Nevertheless, for single-phase equipment, it is permissible to measure the currents in the neutral conductor instead of the currents in the line.
- The EUT is tested as presented by, and in accordance with information provided by, the manufacturer. Preliminary operation of motor drives by the manufacturer may be needed before the tests are undertaken to ensure that results correspond with normal use.
- In all configurations, the use of additional load shall not cause the total output power available to be exceeded.
- The correspondent test program of test instrument to measure the current harmonics emanated from EUT is chosen. The measure time shall be not less than the time necessary for the EUT to be exercised.

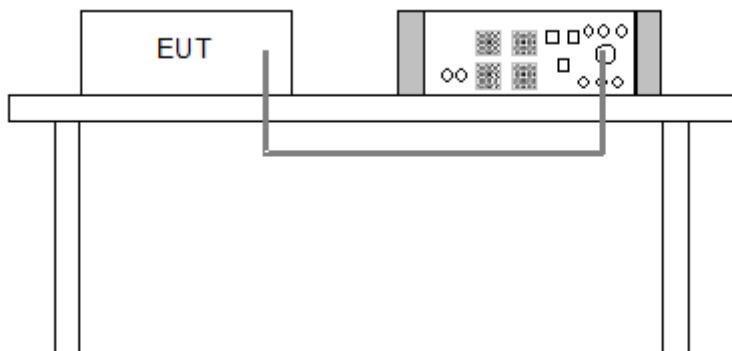

For the actual test configuration, please refer to the related Item – Photographs of the Test Configuration.

6.6 Voltage Fluctuations and Flicker Measurement

- Controls or automatic programs of the EUT shall be set to produce the most unfavourable sequence of voltage changes, using only those combinations of controls and programmes which are mentioned by the manufacturer in the instruction manual, or are otherwise likely to be used.
- Preliminary operation of motor drives may be needed before the tests to ensure that results corresponding to those of normal use are obtained.
- During the flick measurement, the measure time shall include that part of whole operation cycle in which the EUT produce the most unfavorable sequence of voltage changes. The observation period for short-term flicker indicator is 10 minutes and the observation period for long-term flicker indicator is 2 hours.

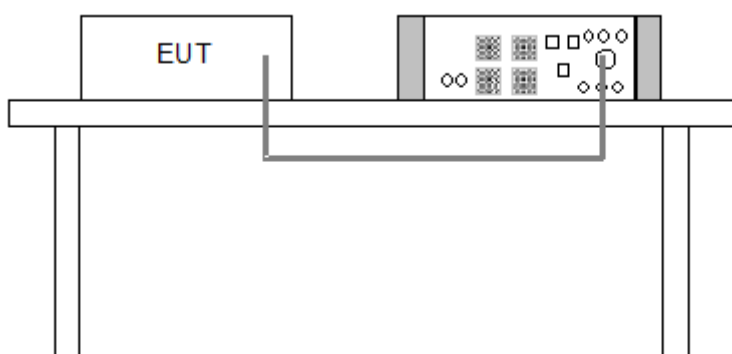

For the actual test configuration, please refer to the related Item – Photographs of the Test Configuration.

6.7 Electrostatic Discharges (ESD)

Discharge Impedance:	330 ohm / 150 pF
Number of Discharge:	Air – Direct: 10 discharges per location (each polarity) Contact – Direct & Indirect: 10 discharges per location (each polarity)
Discharge Period:	1-second minimum

The basic test procedure was in accordance with EN/IEC 61000-4-2:

- a. Electrostatic discharges were applied only to those points and surfaces of the EUT that are accessible to users during normal operation.
- b. The test was performed with at least ten single discharges on the pre-selected points in the most sensitive polarity.
- c. The time interval between two successive single discharges was at least 1 second.
- d. The ESD generator was held perpendicularly to the surface to which the discharge was applied and the return cable was at least 0.2 meters from the EUT.
- e. Contact discharges were applied to the non-insulating coating, with the pointed tip of the generator penetrating the coating and contacting the conducting substrate.
- f. Air discharges were applied with the round discharge tip of the discharge electrode approaching the EUT as fast as possible (without causing mechanical damage) to touch the EUT. After each discharge, the ESD generator was removed from the EUT and re-triggered for a new single discharge. The test was repeated until all discharges were complete.
- g. At least ten single discharges (in the most sensitive polarity) were applied to the **Horizontal Coupling Plane** at points on each side of the EUT. The ESD generator was positioned at a distance of 0.1 meters from the EUT with the discharge electrode touching the **HCP**.
- h. At least ten single discharges (in the most sensitive polarity) were applied to the center of one vertical edge of the **Vertical Coupling Plane** in sufficiently different positions that the four faces of the EUT were completely illuminated. The **VCP** (dimensions 0.5m x 0.5m) was placed vertically to and 0.1 meters from the EUT.

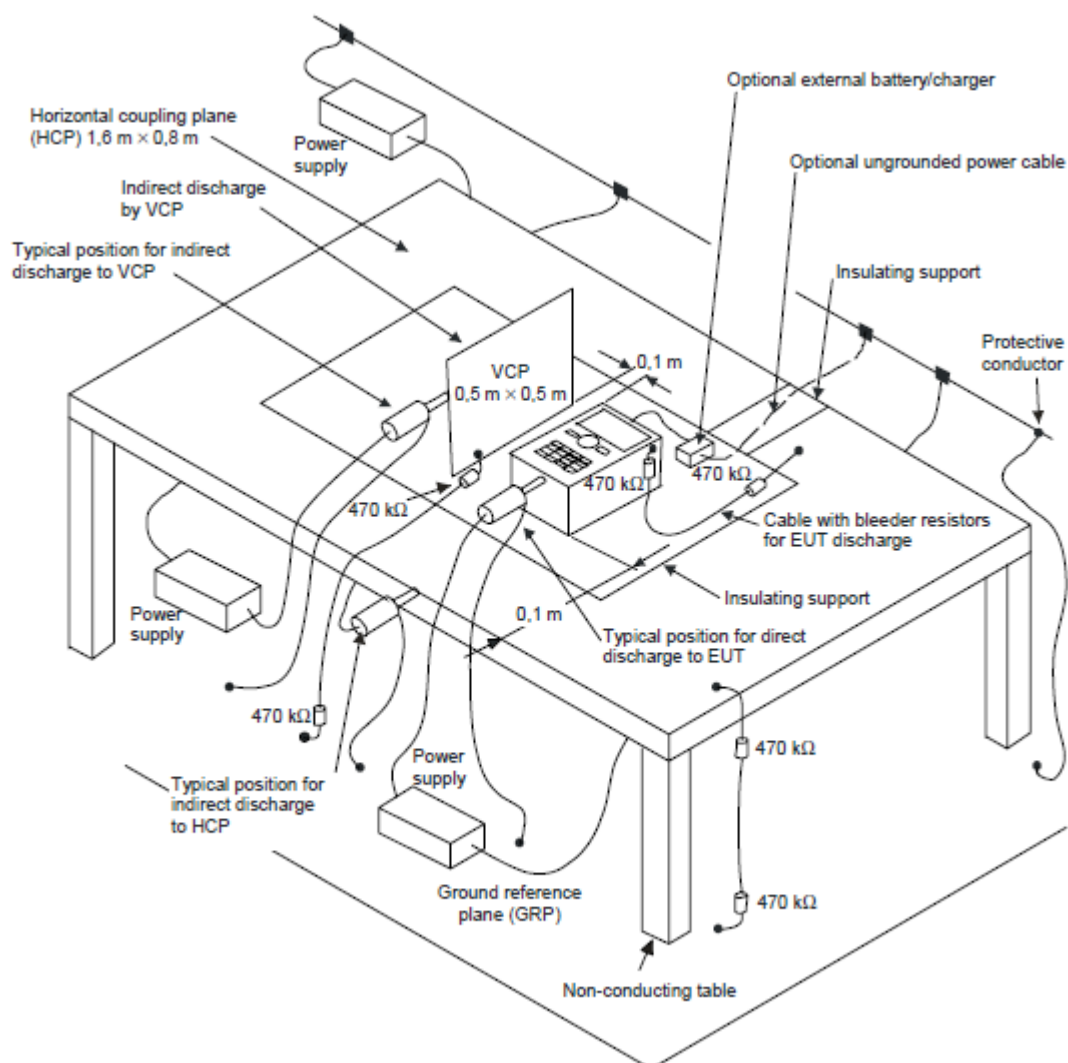

For the actual test configuration, please refer to the related item – Photographs of the Test Configuration.

NOTE:

TABLE-TOP EQUIPMENT

The configuration consisted of a wooden table 0.8 meters high standing on the **Ground Reference Plane**. The **GRP** consisted of a sheet of aluminum at least 0.25mm thick, and 2.5 meters square connected to the protective grounding system. A **Horizontal Coupling Plane** (1.6m x 0.8m) was placed on the table and attached to the **GRP** by means of a cable with 940kΩ total impedance. The equipment under test, was installed in a representative system as described in section 7 of EN/IEC 61000-4-2, and its cables were placed on the **HCP** and isolated by an insulating support of 0.5mm thickness. A distance of 1-meter minimum was provided between the EUT and the walls of the laboratory and any other metallic structure.

FLOOR-STANDING EQUIPMENT

The equipment under test was installed in a representative system as described in section 7 of IEC 61000-4-2, and its cables were isolated from the Ground Reference Plane by an insulating support of 0.1-meter thickness. The GRP consisted of a sheet of aluminum that is at least 0.25mm thick, and 2.5 meters square connected to the protective grounding system and extended at least 0.5 m.

6.8 Radio Frequency Electromagnetic Field (RS)

Modulation:	1kHz Sine Wave, 80%, AM Modulation
Frequency Step:	1 % of preceding frequency value
Dwell Time:	3 seconds

The test procedure was in accordance with EN/IEC 61000-4-3.

- The testing was performed in a modified semi-anechoic chamber.
- The frequency range shall be swept, with the signal 80% amplitude modulated with a 1kHz sine wave.
- The test was performed with the EUT exposed to both vertically and horizontally polarized fields on each of the four sides.

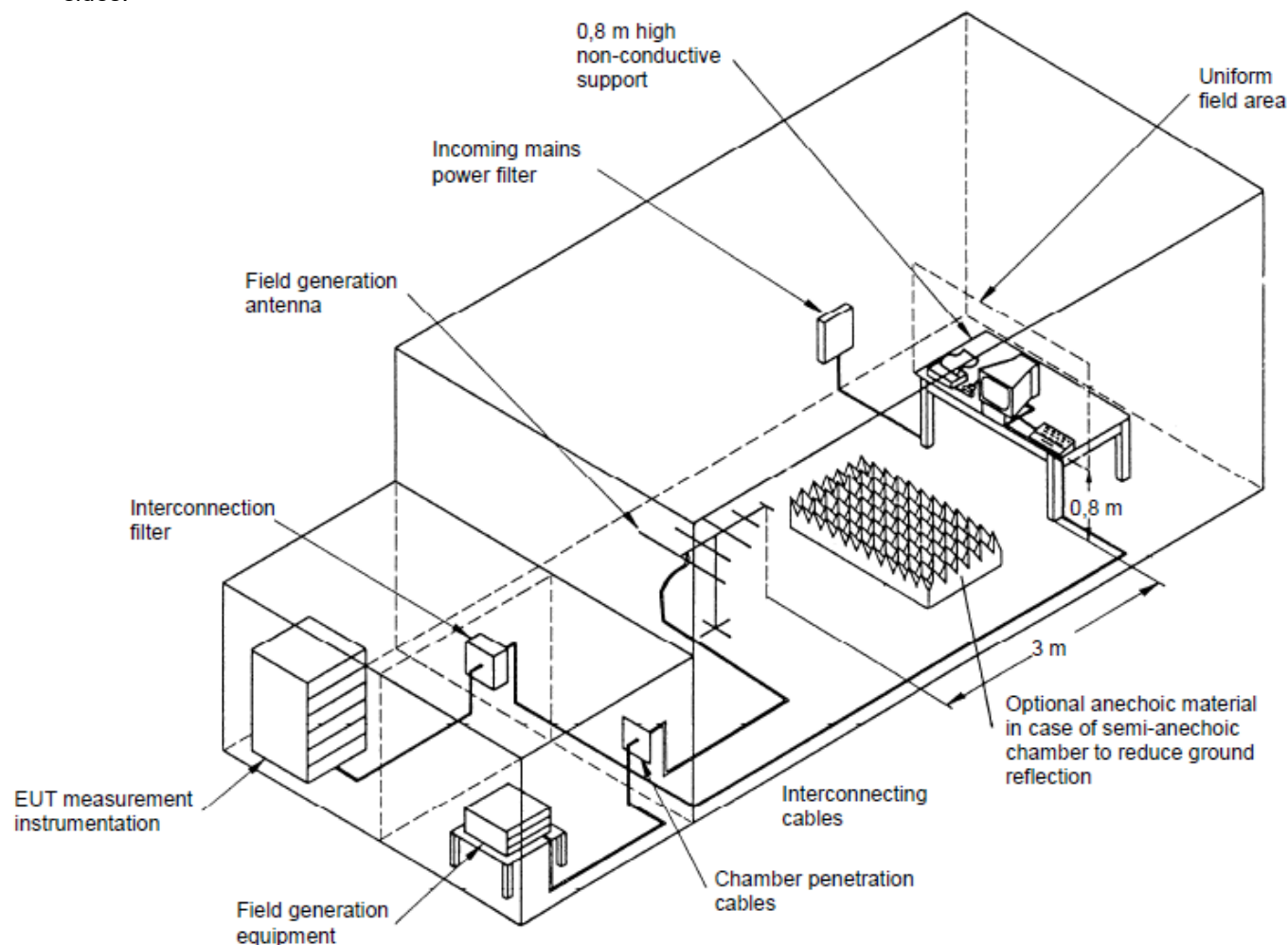

For the actual test configuration, please refer to the related item – Photographs of the Test Configuration.

NOTE:

TABLETOP EQUIPMENT

The EUT installed in a representative system as described in section 7 of EN/IEC 61000-4-3 was placed on a non-conductive table 0.8 meters in height. The system under test was connected to the power and signal wire according to relevant installation instructions.

FLOOR STANDING EQUIPMENT

The EUT installed in a representative system as described in section 7 of EN/IEC 61000-4-3 was placed on a non-conductive wood support 0.1 meters in height. The system under test was connected to the power and signal wire according to relevant installation instructions.

6.9 Fast Transients Common Mode (EFT)

Impulse Repetition Frequency:	xDSL telecommunication port: 100kHz others: 5kHz
Impulse Wave Shape:	5/50 ns
Burst Duration:	0.75 ms for 100kHz Repetition Frequency 15 ms for 5kHz Repetition Frequency
Burst Period:	300 ms
Test Duration:	1 min.

- Both positive and negative polarity discharges were applied.
- The distance between any coupling devices and the EUT should be 0.5 m for table-top equipment testing, and 1.0 m for floor standing equipment.
- The duration time of each test sequential was 1 minute.
- The transient/burst waveform was in accordance with EN/IEC 61000-4-4, 5/50 ns.

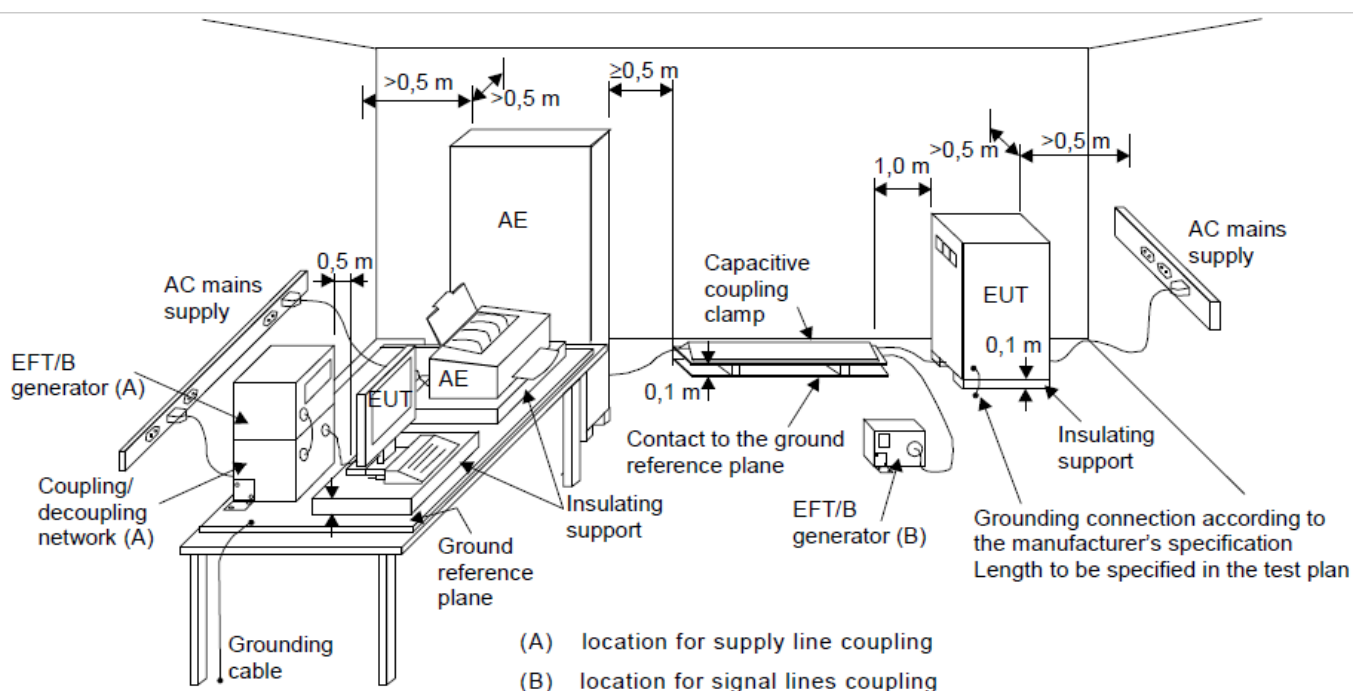

For the actual test configuration, please refer to the related item – Photographs of the Test Configuration.

6.10 Surges

Wave-Shape:	Wired network ports (direct to outdoor cables): Symmetrically operated: 10/700 μ s Open Circuit Voltage 5/320 μ s Short Circuit Current Non-symmetrically operated: 1.2/50 μ s Open Circuit Voltage 8/20 μ s Short Circuit Current Shielded cables (direct to outdoor cables): 1.2/50 μ s Open Circuit Voltage 8/20 μ s Short Circuit Current Wired network ports (indoor cables, longer than 30m): 1.2/50 μ s Open Circuit Voltage 8/20 μ s Short Circuit Current Input DC power port (direct to outdoor cables): 1.2/50 μ s Open Circuit Voltage 8/20 μ s Short Circuit Current Input AC power port: 1.2/50 μ s Open Circuit Voltage 8/20 μ s Short Circuit Current
Pulse Repetition Rate:	20 sec.
Number of Tests:	5 positive and 5 negative at selected points

a. EUT Power ports:

The surge shall be applied to the EUT power supply terminals via the capacitive coupling network. Decoupling networks are required in order to avoid possible adverse effects on equipment not under test that may be powered by the same lines and to provide sufficient decoupling impedance to the surge wave. The power cord between the EUT and the coupling network shall not exceed 2 meters in length.

For double-insulated products without PE or external earth connections, the test shall be done in a similar way as for grounded products but without adding any additional external grounded connections. If there are no other possible connections to earth, line-to-ground tests may be omitted.

b. Wired network ports

- Unshielded unsymmetrical interconnection lines:

The coupling / decoupling networks shall not influence the specified functional conditions of the EUT. The interconnection line between the EUT and the coupling network shall not exceed 2 meters in length.

No line-to-ground surges are applied for double-insulated products (i.e. products without any dedicated earth terminal).

- Unshielded symmetrical interconnection lines:

For symmetrical interconnection lines and high-speed interconnection lines, the CDN shall be selected to match the number of lines/pairs existing the cable. If coupling arrestors are use, test levels below the ignition point of the coupling arrestor cannot be specified.

The interconnection line between the EUT and the coupling/decoupling networks shall not exceed 2 meters in length.

In order to avoid the coupling and decoupling capacitors having a filtering effect on the data transfer, a balanced high frequency design associating the coupling capacitors with coupling chokes is required. Where normal functioning of high speed communications lines cannot be achieved because of the impact of the CDN on the EUT, product committees should specify appropriate operation or that no surge immunity test is required.

- Shielded lines:

The EUT is isolated from ground and the surge is applied to its metallic enclosure; the termination (or auxiliary equipment) at the port(s) under test is grounded. This test applies to equipment with one or more shielded cables.

The length of the cable between the port(s) under test and the device attached to the other end of the cable (AE in Figure 12) shall be:

- 20 m (preferred length) or,
- the shortest length over 10 m, where the manufacturer provides pre-assembled cables used in actual installations.

No test shall be required for cables which according to the manufacturer's specification are ≤ 10 m.

Rules for application of the surge to shielded lines:

- a) Shields grounded at both ends:
– the test shall be carried out.

The test level is applied on shields with a $2\ \Omega$ generator source impedance and with the $18\ \mu\text{F}$ capacitor.

- b) Shields grounded at one end:
– the test shall be carried out according to unshielded unsymmetrical interconnection lines or unshielded symmetrical interconnection lines because the shield does not provide any protection against surges induced by magnetic fields.

For EUTs which do not have metallic enclosures, the surge is applied directly to the shielded cable at the EUT side.

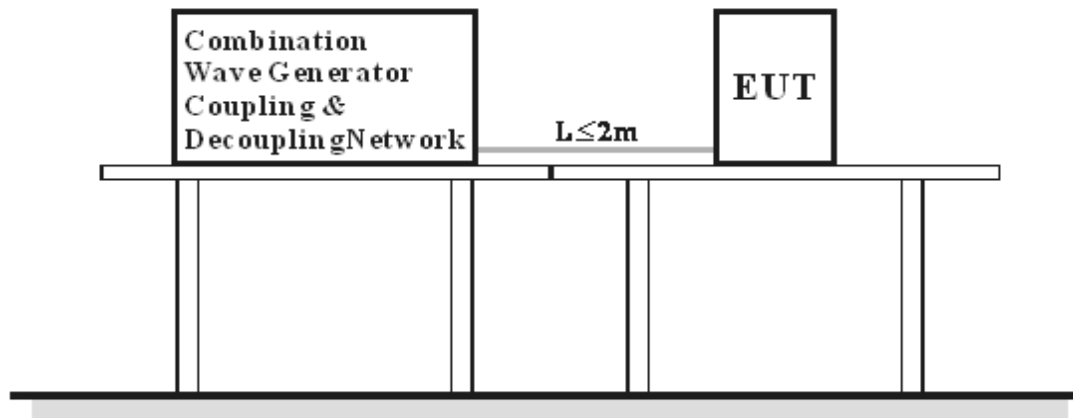

For the actual test configuration, please refer to the related item – Photographs of the Test Configuration.

6.11 Radio Frequency Common Mode (CS)

Modulation:	1kHz Sine Wave, 80%, AM Modulation
Frequency Step:	1 % of preceding frequency value
Dwell Time	3 seconds

- The EUT shall be tested within its intended operating and climatic conditions.
- An artificial hand was placed on the hand-held accessory and connected to the ground reference plane.
- One of the CDNs not used for injection was terminated with 50 ohm, providing only one return path. All other CDNs were coupled as decoupling networks.
- The frequency range shall be swept, using the signal level established during the setting process and with a disturbance signal of 80 % amplitude. The signal is modulated with a 1 kHz sine wave, pausing to adjust the RF signal level or the switch coupling devices as necessary. Where the frequency is swept incrementally, the step size shall not exceed 1 % of the preceding frequency value.
- Attempts should be made to fully exercise the EUT during testing, and to fully interrogate all exercise modes selected for susceptibility.

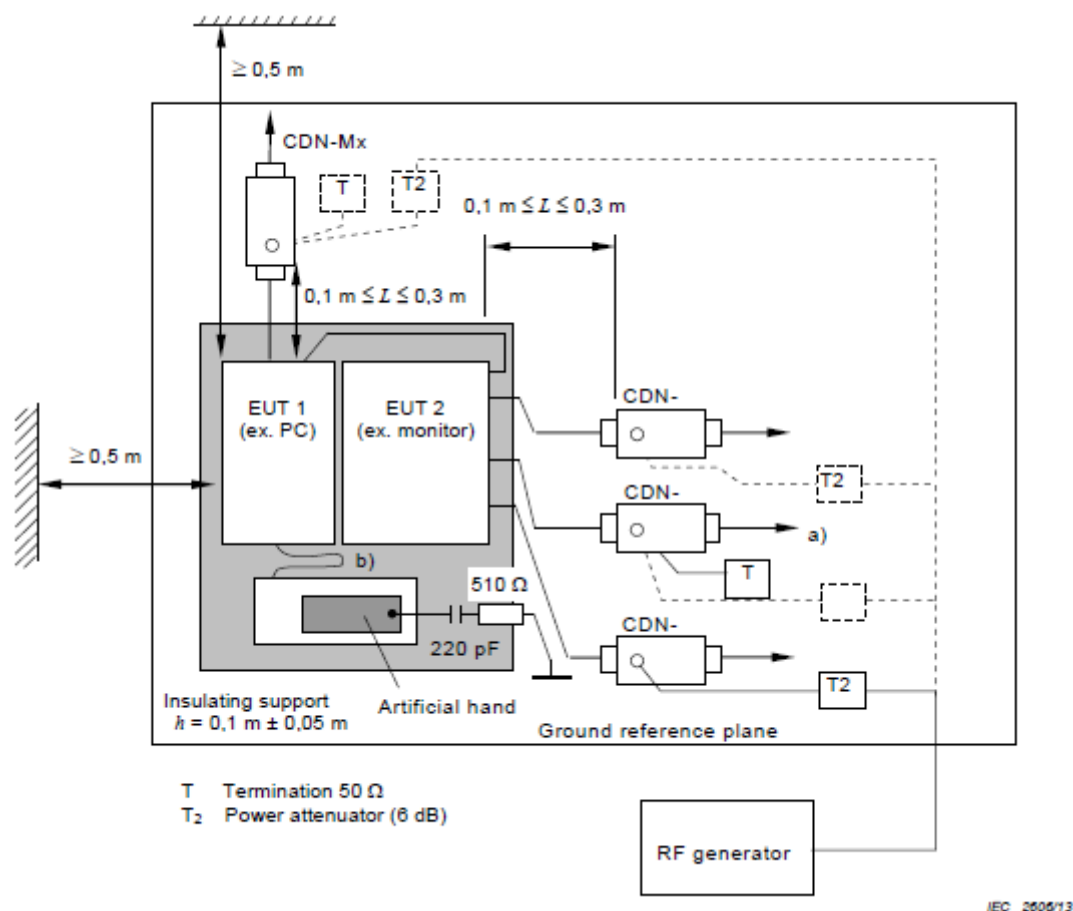

- Note:**
- The EUT clearance from any metallic obstacles shall be at least 0,5 m.
 - Interconnecting cables (≤ 1 m) belonging to the EUT shall remain on the insulating support.
- For the actual test configuration, please refer to the related item – Photographs of the Test Configuration.

Broadband impulse noise disturbances, Repetitive and Isolated (Applicable only to xDSL ports.)

- a. The EUT shall be tested within its intended operating and climatic conditions.
- b. An artificial hand was placed on the hand-held accessory and connected to the ground reference plane.
- c. One of the CDNs not used for injection was terminated with 50 ohm, providing only one return path. All other CDNs were coupled as decoupling networks.
- d. For the repetitive impulse test the disturbance shall be applied for a period of at least 2 minutes for each port under test.
- e. For the isolated impulse test a minimum of 5 isolated impulses shall be applied with an interval of at least 60 seconds between successive impulses.
- f. Attempts should be made to fully exercise the EUT during testing, and to fully interrogate all exercise modes selected for susceptibility.

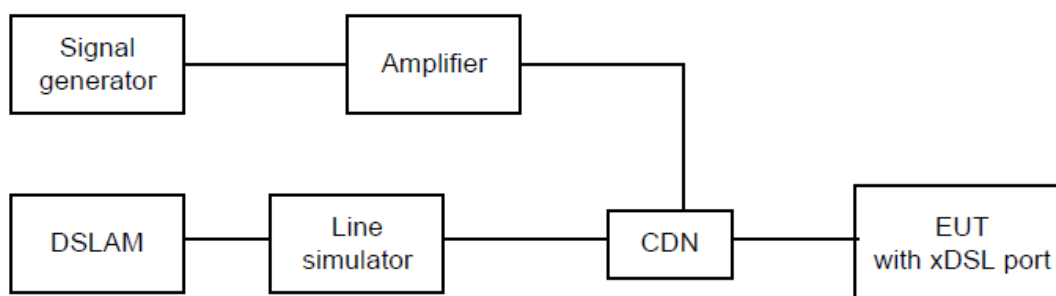

Example schematic of the broadband impulsive conducted disturbances test setup

For the actual test configuration, please refer to the related item – Photographs of the Test Configuration.

6.12 Power Frequency Magnetic Field (PFMF)

Observation Time:	1 minute
Inductance Coil:	Rectangular coil, 1 m x 1 m (L x W) or 2.6 m x 1 m (L x W)

- The equipment is configured and connected to satisfy its functional requirements.
- The power supply, input and output circuits shall be connected to the sources of power supply, control and signal.
- The cables supplied or recommended by the equipment manufacturer shall be used. 1 meter of all cables used shall be exposed to the magnetic field.

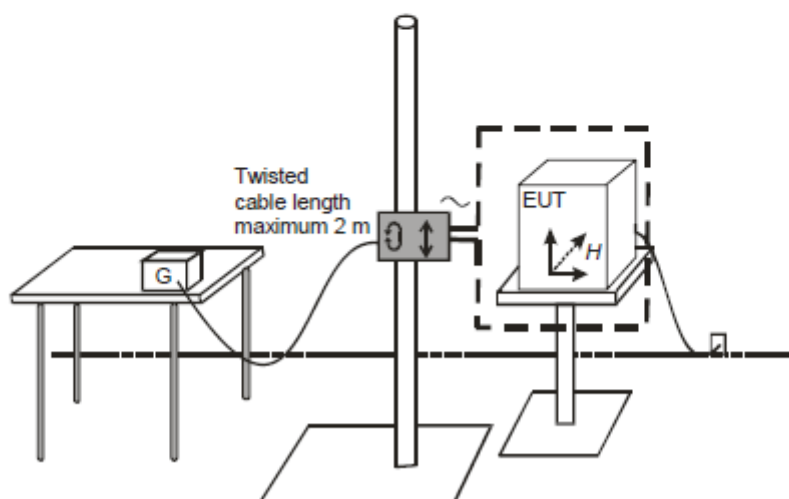
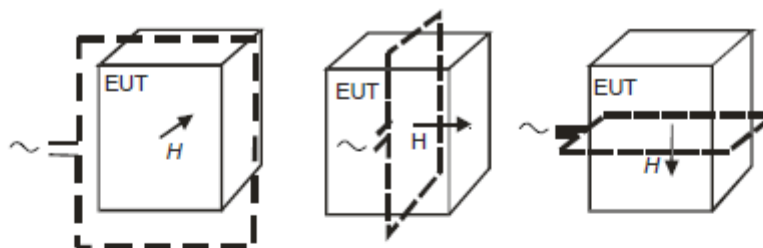

For the actual test configuration, please refer to the related item – Photographs of the Test Configuration.

6.13 Voltage Dips and Interruptions (DIP)

Interval between Event:	10 seconds
Sync Angle (degrees):	0° / 180°
Test Cycle:	3 times

- a. The test shall be performed with the EUT connected to the test generator with the shortest power supply cable as specified by the EUT manufacturer. If no cable length is specified, it shall be the shortest possible length suitable to the application of the EUT.
- b. The EUT shall be tested for each selected combination of test levels and duration with a sequence of 3 dips/interruptions with intervals of 10 s minimum (between each test event). Each representative mode of operation shall be tested. Abrupt changes in supply voltage shall occur at 0 voltage crossover point of the voltage waveform.

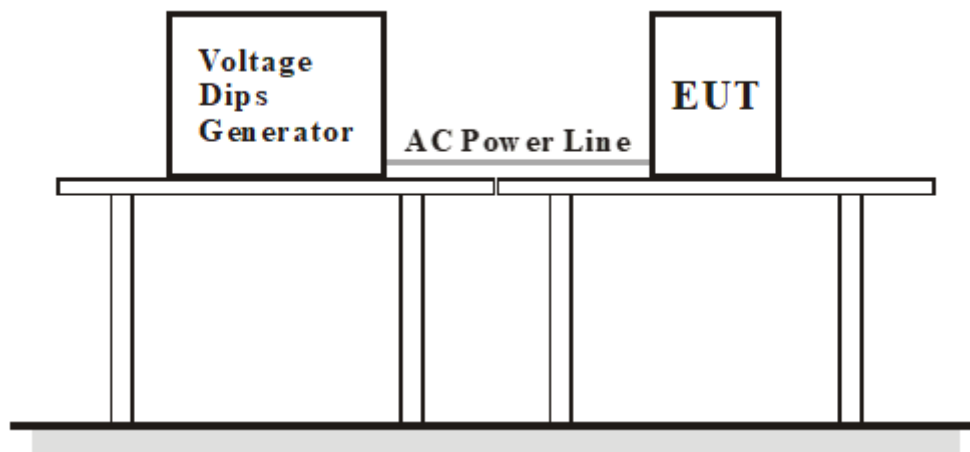

For the actual test configuration, please refer to the related item – Photographs of the Test Configuration.

7 Test Results of Test Item

7.1 Conducted Emissions from Power Ports

Mode A

Frequency Range	150 kHz ~ 30 MHz	Detector Function & Resolution Bandwidth	Quasi-Peak (QP) / Average (AV), 9 kHz
Input Power	230 Vac, 50 Hz	Environmental Conditions	27 °C, 77 % RH, 999.9 mbar
Tested by	Kenny Chang		

Phase Of Power : Line (L)										
No	Frequency (MHz)	Correction Factor (dB)	Reading Value (dBuV)		Emission Level (dBuV)		Limit (dBuV)		Margin (dB)	
			Q.P.	AV.	Q.P.	AV.	Q.P.	AV.	Q.P.	AV.
1	0.15012	9.98	40.89	27.58	50.87	37.56	79.00	66.00	-28.13	-28.44
2	0.23995	10.00	38.14	28.96	48.14	38.96	79.00	66.00	-30.86	-27.04
3	0.75813	10.03	30.83	19.82	40.86	29.85	73.00	60.00	-32.14	-30.15
4	0.92105	10.03	33.13	20.35	43.16	30.38	73.00	60.00	-29.84	-29.62
5	1.54815	10.06	33.37	22.40	43.43	32.46	73.00	60.00	-29.57	-27.54
6	13.22874	10.45	29.48	22.09	39.93	32.54	73.00	60.00	-33.07	-27.46

Remarks:

1. Q.P. and AV. are abbreviations of quasi-peak and average individually.
2. The emission levels of other frequencies were very low against the limit.
3. Margin value = Emission level – Limit value
4. Correction factor = Insertion loss + Cable loss
5. Emission Level = Correction Factor + Reading Value

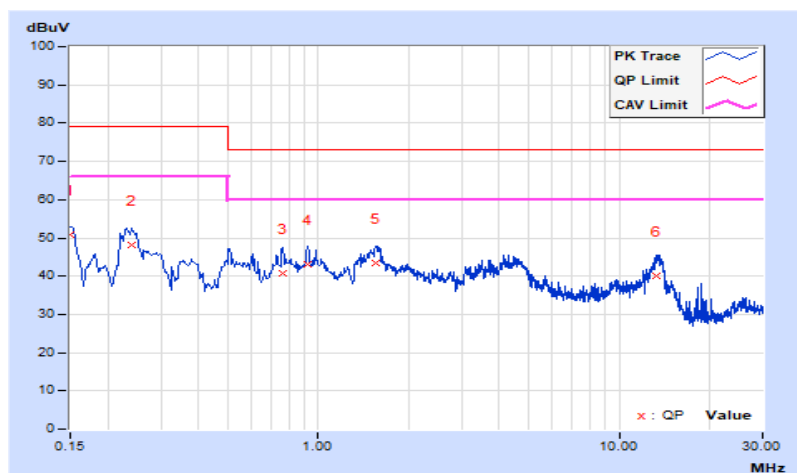

Frequency Range	150 kHz ~ 30 MHz	Detector Function & Resolution Bandwidth	Quasi-Peak (QP) / Average (AV), 9 kHz
Input Power	230 Vac, 50 Hz	Environmental Conditions	27 °C, 77 % RH, 999.9 mbar
Tested by	Kenny Chang		

Phase Of Power : Neutral (N)										
No	Frequency (MHz)	Correction Factor (dB)	Reading Value (dBuV)		Emission Level (dBuV)		Limit (dBuV)		Margin (dB)	
			Q.P.	AV.	Q.P.	AV.	Q.P.	AV.	Q.P.	AV.
1	0.22024	9.98	38.52	21.12	48.50	31.10	79.00	66.00	-30.50	-34.90
2	0.25169	9.98	38.23	25.23	48.21	35.21	79.00	66.00	-30.79	-30.79
3	0.32991	9.98	31.98	17.59	41.96	27.57	79.00	66.00	-37.04	-38.43
4	0.91065	10.01	30.85	15.78	40.86	25.79	73.00	60.00	-32.14	-34.21
5	1.50513	10.04	30.64	18.72	40.68	28.76	73.00	60.00	-32.32	-31.24
6	4.43838	10.15	29.48	21.17	39.63	31.32	73.00	60.00	-33.37	-28.68

Remarks:

1. Q.P. and AV. are abbreviations of quasi-peak and average individually.
2. The emission levels of other frequencies were very low against the limit.
3. Margin value = Emission level – Limit value
4. Correction factor = Insertion loss + Cable loss
5. Emission Level = Correction Factor + Reading Value

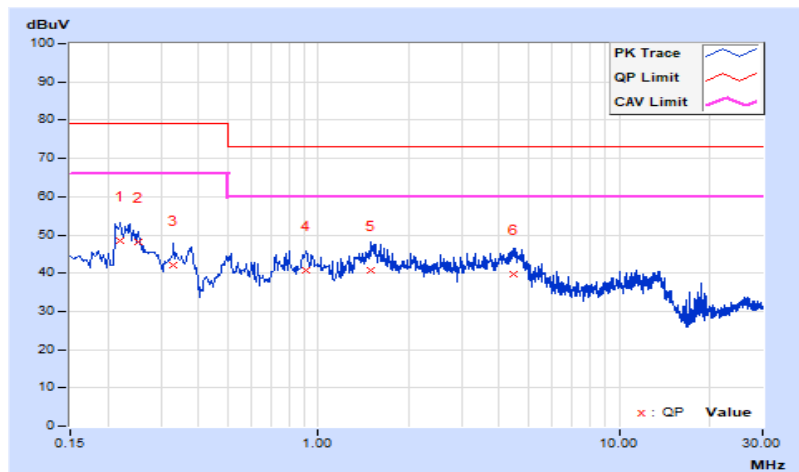

7.2 Conducted Emissions from Wired Network Ports

Mode A

Frequency Range	150 kHz ~ 30 MHz	Detector Function & Resolution Bandwidth	Quasi-Peak (QP) / Average (AV), 9 kHz
Input Power	230 Vac, 50 Hz	Environmental Conditions	27 °C, 77 % RH, 999.6 mbar
Tested by	Kenny Chang		

No	Frequency (MHz)	Correction Factor (dB)	Reading Value (dBuV)		Emission Level (dBuV)		Limit (dBuV)		Margin (dB)	
			Q.P.	AV.	Q.P.	AV.	Q.P.	AV.	Q.P.	AV.
1	0.49325	9.74	45.08	38.95	54.82	48.69	87.11	74.11	-32.29	-25.42
2	0.60566	9.73	45.63	36.07	55.36	45.80	87.00	74.00	-31.64	-28.20
3	1.17163	9.70	56.23	54.86	65.93	64.56	87.00	74.00	-21.07	-9.44
4	1.35267	9.70	54.52	44.79	64.22	54.49	87.00	74.00	-22.78	-19.51
5	1.50904	9.71	54.69	44.92	64.40	54.63	87.00	74.00	-22.60	-19.37
6	1.64592	9.72	54.25	46.85	63.97	56.57	87.00	74.00	-23.03	-17.43
7	3.19077	9.78	55.69	39.51	65.47	49.29	87.00	74.00	-21.53	-24.71
8	8.49252	9.98	53.05	52.33	63.03	62.31	87.00	74.00	-23.97	-11.69

Remarks:

1. Q.P. and AV. are abbreviations of quasi-peak and average individually.
2. The emission levels of other frequencies were very low against the limit.
3. Margin value = Emission level – Limit value
4. Correction factor = Insertion loss + Cable loss
5. Emission Level = Correction Factor + Reading Value

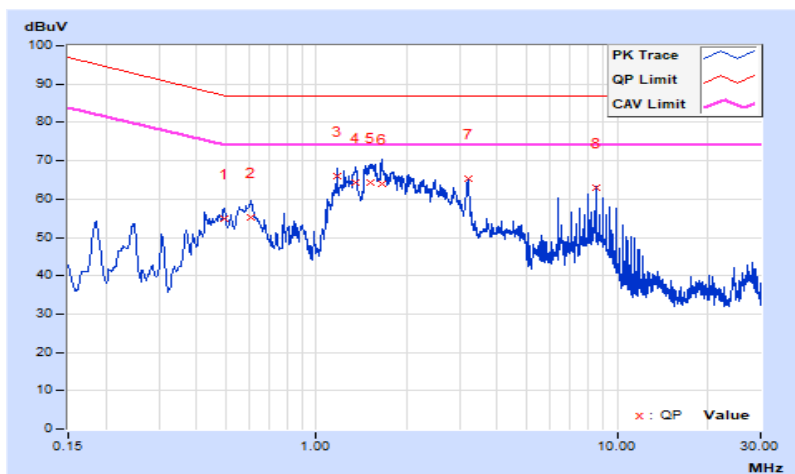

Mode B

Frequency Range	150 kHz ~ 30 MHz	Detector Function & Resolution Bandwidth	Quasi-Peak (QP) / Average (AV), 9 kHz
Input Power	230 Vac, 50 Hz	Environmental Conditions	27 °C, 77 % RH, 999.6 mbar
Tested by	Kenny Chang		

No	Frequency (MHz)	Correction Factor (dB)	Reading Value (dBuV)		Emission Level (dBuV)		Limit (dBuV)		Margin (dB)	
			Q.P.	AV.	Q.P.	AV.	Q.P.	AV.	Q.P.	AV.
1	0.43159	9.75	43.23	38.00	52.98	47.75	88.22	75.22	-35.24	-27.47
2	0.58213	9.73	46.70	38.72	56.43	48.45	87.00	74.00	-30.57	-25.55
3	1.52859	9.71	55.48	46.97	65.19	56.68	87.00	74.00	-21.81	-17.32
4	1.70459	9.72	56.01	43.22	65.73	52.94	87.00	74.00	-21.27	-21.06
5	2.47114	9.75	50.61	43.36	60.36	53.11	87.00	74.00	-26.64	-20.89
6	3.17121	9.78	51.00	39.06	60.78	48.84	87.00	74.00	-26.22	-25.16
7	8.49096	9.98	52.89	52.15	62.87	62.13	87.00	74.00	-24.13	-11.87

Remarks:

1. Q.P. and AV. are abbreviations of quasi-peak and average individually.
2. The emission levels of other frequencies were very low against the limit.
3. Margin value = Emission level – Limit value
4. Correction factor = Insertion loss + Cable loss
5. Emission Level = Correction Factor + Reading Value

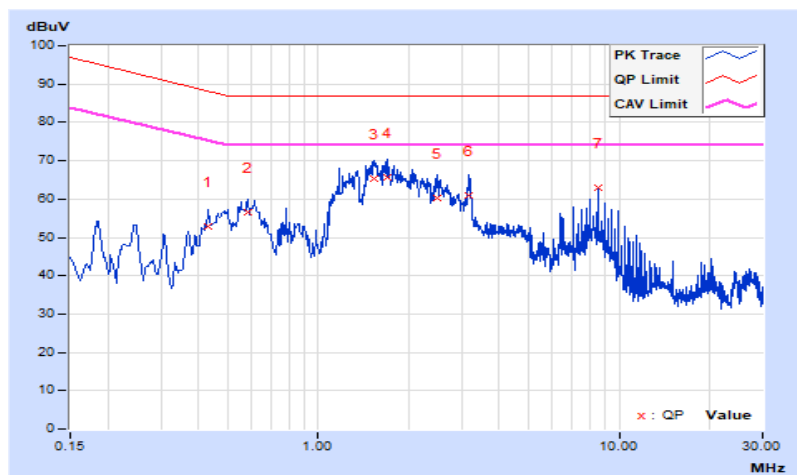

Mode C

Frequency Range	150 kHz ~ 30 MHz	Detector Function & Resolution Bandwidth	Quasi-Peak (QP) / Average (AV), 9 kHz
Input Power	230 Vac, 50 Hz	Environmental Conditions	27 °C, 77 % RH, 999.8 mbar
Tested by	Kenny Chang		

No	Frequency (MHz)	Correction Factor (dB)	Reading Value (dBuV)		Emission Level (dBuV)		Limit (dBuV)		Margin (dB)	
			Q.P.	AV.	Q.P.	AV.	Q.P.	AV.	Q.P.	AV.
1	0.24777	9.76	42.84	39.14	52.60	48.90	92.83	79.83	-40.23	-30.93
2	1.17159	9.70	56.59	55.50	66.29	65.20	87.00	74.00	-20.71	-8.80
3	1.41908	9.71	55.56	45.22	65.27	54.93	87.00	74.00	-21.73	-19.07
4	1.77107	9.72	53.89	44.74	63.61	54.46	87.00	74.00	-23.39	-19.54
5	3.18686	9.78	57.65	41.20	67.43	50.98	87.00	74.00	-19.57	-23.02
6	8.48861	9.98	49.00	48.63	58.98	58.61	87.00	74.00	-28.02	-15.39

Remarks:

1. Q.P. and AV. are abbreviations of quasi-peak and average individually.
2. The emission levels of other frequencies were very low against the limit.
3. Margin value = Emission level – Limit value
4. Correction factor = Insertion loss + Cable loss
5. Emission Level = Correction Factor + Reading Value

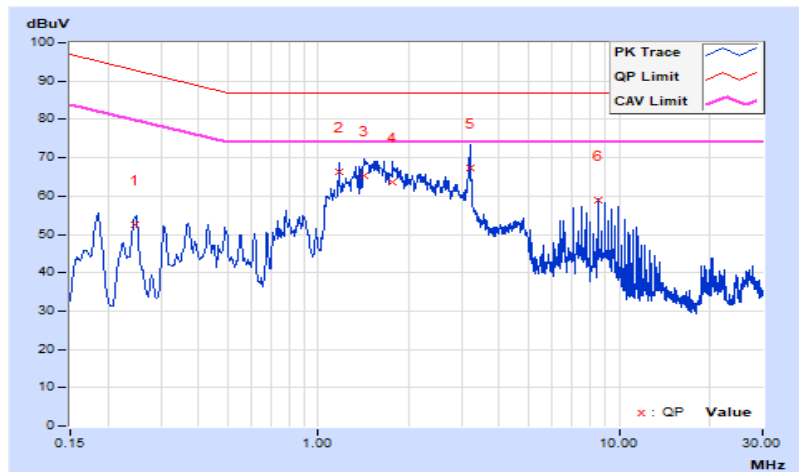

Mode D

Frequency Range	150 kHz ~ 30 MHz	Detector Function & Resolution Bandwidth	Quasi-Peak (QP) / Average (AV), 9 kHz
Input Power	230 Vac, 50 Hz	Environmental Conditions	27 °C, 77 % RH, 999.9 mbar
Tested by	Kenny Chang		

No	Frequency (MHz)	Correction Factor (dB)	Reading Value (dBuV)		Emission Level (dBuV)		Limit (dBuV)		Margin (dB)	
			Q.P.	AV.	Q.P.	AV.	Q.P.	AV.	Q.P.	AV.
1	0.18509	9.76	44.62	41.16	54.38	50.92	95.25	82.25	-40.87	-31.33
2	1.34869	9.70	51.12	40.42	60.82	50.12	87.00	74.00	-26.18	-23.88
3	1.56215	9.71	54.96	52.49	64.67	62.20	87.00	74.00	-22.33	-11.80
4	1.77979	9.72	53.45	44.34	63.17	54.06	87.00	74.00	-23.83	-19.94
5	3.20641	9.78	46.16	33.66	55.94	43.44	87.00	74.00	-31.06	-30.56
6	8.00641	9.96	51.79	51.25	61.75	61.21	87.00	74.00	-25.25	-12.79

Remarks:

1. Q.P. and AV. are abbreviations of quasi-peak and average individually.
2. The emission levels of other frequencies were very low against the limit.
3. Margin value = Emission level – Limit value
4. Correction factor = Insertion loss + Cable loss
5. Emission Level = Correction Factor + Reading Value

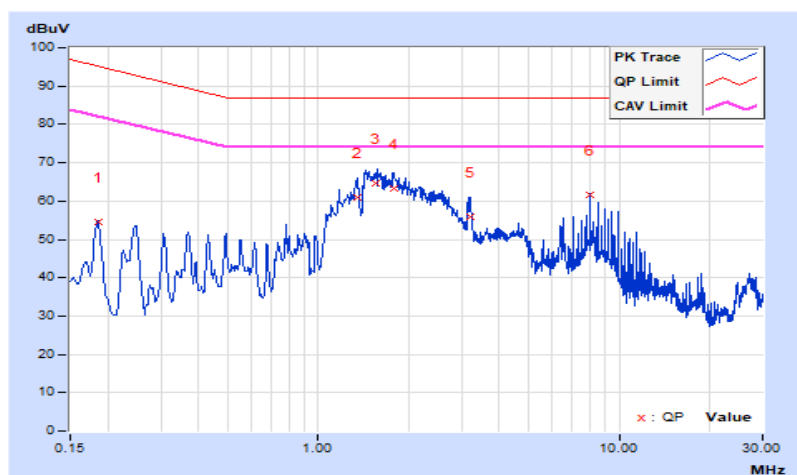

7.3 Radiated Emissions up to 1 GHz

Mode A

Frequency Range	30 MHz ~ 1 GHz	Detector Function & Resolution Bandwidth	Quasi-Peak (QP), 120 kHz
Input Power	230 Vac, 50 Hz	Environmental Conditions	26 °C, 66 % RH, 1000.8 mbar
Tested By	Abraham Sun		

Antenna Polarity & Test Distance : Horizontal at 10 m								
No	Frequency (MHz)	Emission Level (dBuV/m)	Limit (dBuV/m)	Margin (dB)	Antenna Height (m)	Table Angle (Degree)	Raw Value (dBuV)	Correction Factor (dB/m)
1	153.97	31.47 QP	40.00	-8.53	4.00 H	265	47.56	-16.09
2	211.71	29.35 QP	40.00	-10.65	4.00 H	358	48.49	-19.14
3	307.97	37.37 QP	47.00	-9.63	4.00 H	214	52.32	-14.95
4	421.62	33.39 QP	47.00	-13.61	2.98 H	166	45.40	-12.01
5	461.97	36.95 QP	47.00	-10.05	2.13 H	67	48.06	-11.11
6	615.98	39.94 QP	47.00	-7.06	1.99 H	2	47.55	-7.61
7	699.53	33.85 QP	47.00	-13.15	1.00 H	337	40.70	-6.85
8	769.98	38.22 QP	47.00	-8.78	1.00 H	204	43.33	-5.11
9	899.31	36.00 QP	47.00	-11.00	1.84 H	54	39.81	-3.81
10	923.95	35.99 QP	47.00	-11.01	1.06 H	178	38.65	-2.66

Remarks:

1. Emission Level(dBuV/m) = Raw Value(dBuV) + Correction Factor(dB/m)
2. Correction Factor(dB/m) = Antenna Factor (dB/m) + Cable Factor (dB)
– Pre-Amplifier Factor (dB)
3. Margin value = Emission level – Limit value
4. The other emission levels were very low against the limit.

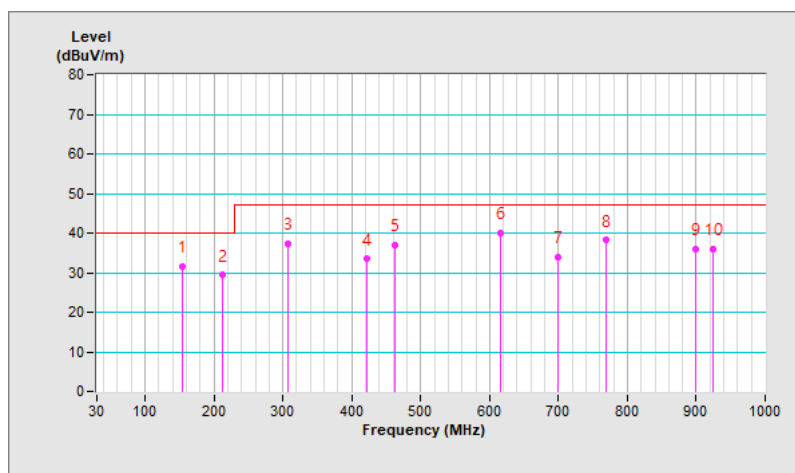

Frequency Range	30 MHz ~ 1 GHz	Detector Function & Resolution Bandwidth	Quasi-Peak (QP), 120 kHz
Input Power	230 Vac, 50 Hz	Environmental Conditions	26 °C, 66 % RH, 1000.8 mbar
Tested By	Abraham Sun		

Antenna Polarity & Test Distance : Vertical at 10 m								
No	Frequency (MHz)	Emission Level (dBuV/m)	Limit (dBuV/m)	Margin (dB)	Antenna Height (m)	Table Angle (Degree)	Raw Value (dBuV)	Correction Factor (dB/m)
1	30.00	36.04 QP	40.00	-3.96	1.00 V	223	55.53	-19.49
2	153.97	35.43 QP	40.00	-4.57	1.00 V	284	52.14	-16.71
3	212.81	36.26 QP	40.00	-3.74	1.00 V	306	56.14	-19.88
4	307.97	36.10 QP	47.00	-10.90	2.11 V	320	51.96	-15.86
5	406.23	35.98 QP	47.00	-11.02	4.00 V	310	49.48	-13.50
6	461.97	40.56 QP	47.00	-6.44	1.53 V	320	52.50	-11.94
7	615.98	38.53 QP	47.00	-8.47	1.79 V	85	47.07	-8.54
8	698.49	36.18 QP	47.00	-10.82	2.88 V	158	43.90	-7.72
9	769.98	38.80 QP	47.00	-8.20	2.00 V	266	44.93	-6.13
10	923.95	34.41 QP	47.00	-12.59	1.90 V	70	37.93	-3.52

Remarks:

1. Emission Level(dBuV/m) = Raw Value(dBuV) + Correction Factor(dB/m)
2. Correction Factor(dB/m) = Antenna Factor (dB/m) + Cable Factor (dB) – Pre-Amplifier Factor (dB)
3. Margin value = Emission level – Limit value
4. The other emission levels were very low against the limit.

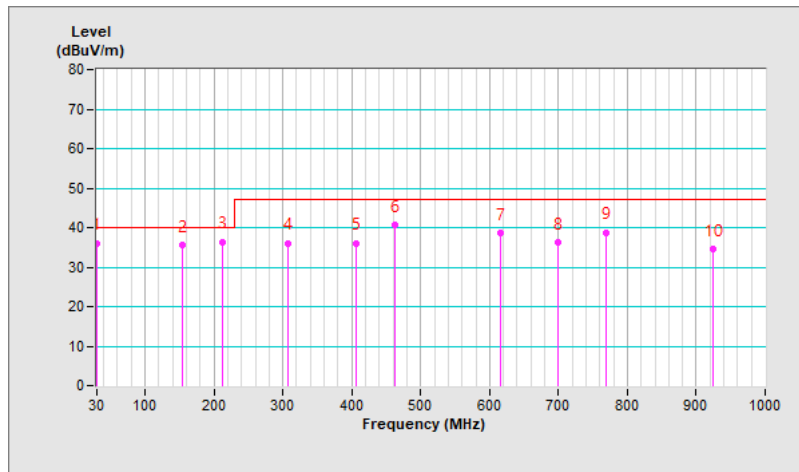

7.4 Radiated Emissions above 1 GHz

Mode A

Frequency Range	1 GHz ~ 6 GHz	Detector Function & Resolution Bandwidth	Peak (PK) / Average (AV), 1 MHz
Input Power	230 Vac, 50 Hz	Environmental Conditions	25 °C, 71 % RH, 1000.4 mbar
Tested By	Chin-Wen Wang		

Antenna Polarity & Test Distance : Horizontal at 3 m								
No	Frequency (MHz)	Emission Level (dBuV/m)	Limit (dBuV/m)	Margin (dB)	Antenna Height (m)	Table Angle (Degree)	Raw Value (dBuV)	Correction Factor (dB/m)
1	1783.33	53.62 PK	76.00	-22.38	2.18 H	341	64.99	-11.37
2	1783.33	36.38 AV	56.00	-19.62	2.18 H	341	47.75	-11.37
3	1971.83	55.91 PK	76.00	-20.09	1.54 H	358	66.64	-10.73
4	1971.83	38.71 AV	56.00	-17.29	1.54 H	358	49.44	-10.73
5	2194.50	56.83 PK	76.00	-19.17	2.45 H	286	67.12	-10.29
6	2194.50	38.63 AV	56.00	-17.37	2.45 H	286	48.92	-10.29
7	2398.03	56.10 PK	76.00	-19.90	1.53 H	230	65.53	-9.43
8	2398.03	41.37 AV	56.00	-14.63	1.53 H	230	50.80	-9.43
9	3695.83	56.95 PK	80.00	-23.05	1.62 H	209	64.44	-7.49
10	3695.83	44.50 AV	60.00	-15.50	1.62 H	209	51.99	-7.49
11	4992.83	56.56 PK	80.00	-23.44	1.00 H	192	63.52	-6.96
12	4992.83	42.59 AV	60.00	-17.41	1.00 H	192	49.55	-6.96
13	5999.98	70.12 PK	80.00	-9.88	2.10 H	190	76.07	-5.95
14	5999.98	59.32 AV	60.00	-0.68	2.10 H	190	65.27	-5.95

Remarks:

- Emission Level(dBuV/m) = Raw Value(dBuV) + Correction Factor(dB/m)
- Correction Factor(dB/m) = Antenna Factor (dB/m) + Cable Factor (dB)
– Pre-Amplifier Factor (dB)
- Margin value = Emission level – Limit value
- The other emission levels were very low against the limit.

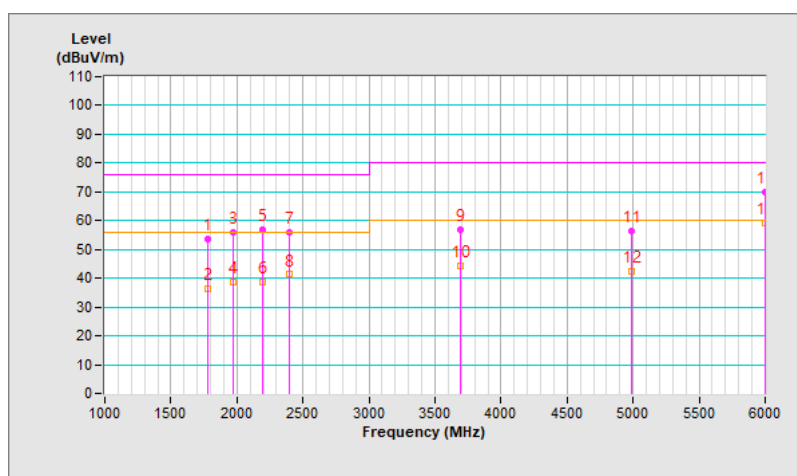

Frequency Range	1 GHz ~ 6 GHz	Detector Function & Resolution Bandwidth	Peak (PK) / Average (AV), 1 MHz
Input Power	230 Vac, 50 Hz	Environmental Conditions	25 °C, 71 % RH, 1000.2 mbar
Tested By	Chin-Wen Wang		

Antenna Polarity & Test Distance : Vertical at 3 m								
No	Frequency (MHz)	Emission Level (dBuV/m)	Limit (dBuV/m)	Margin (dB)	Antenna Height (m)	Table Angle (Degree)	Raw Value (dBuV)	Correction Factor (dB/m)
1	1799.17	55.92 PK	76.00	-20.08	2.44 V	291	66.88	-10.96
2	1799.17	37.40 AV	56.00	-18.60	2.44 V	291	48.36	-10.96
3	1980.00	53.93 PK	76.00	-22.07	2.19 V	344	64.74	-10.81
4	1980.00	37.51 AV	56.00	-18.49	2.19 V	344	48.32	-10.81
5	2170.83	56.43 PK	76.00	-19.57	1.65 V	258	66.56	-10.13
6	2170.83	38.87 AV	56.00	-17.13	1.65 V	258	49.00	-10.13
7	2399.00	59.65 PK	76.00	-16.35	1.00 V	232	69.09	-9.44
8	2399.00	45.16 AV	56.00	-10.84	1.00 V	232	54.60	-9.44
9	4997.83	57.14 PK	80.00	-22.86	1.57 V	356	64.09	-6.95
10	4997.83	41.83 AV	60.00	-18.17	1.57 V	356	48.78	-6.95
11	5999.96	67.06 PK	80.00	-12.94	2.11 V	207	73.01	-5.95
12	5999.96	57.14 AV	60.00	-2.86	2.11 V	207	63.09	-5.95

Remarks:

1. Emission Level(dBuV/m) = Raw Value(dBuV) + Correction Factor(dB/m)
2. Correction Factor(dB/m) = Antenna Factor (dB/m) + Cable Factor (dB) – Pre-Amplifier Factor (dB)
3. Margin value = Emission level – Limit value
4. The other emission levels were very low against the limit.

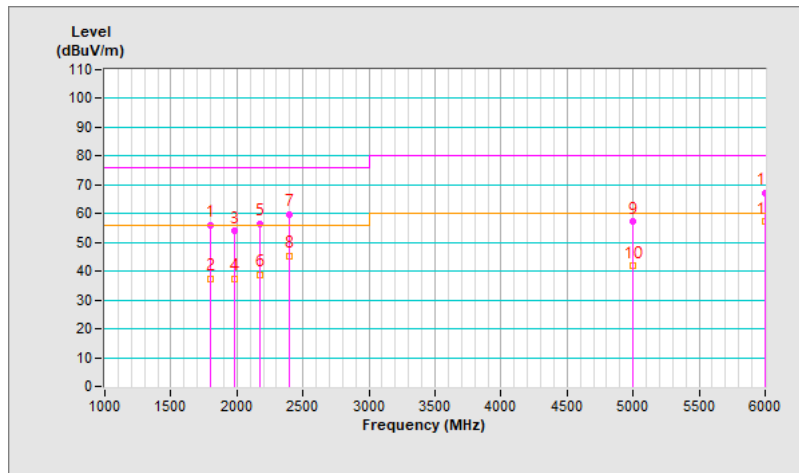

7.5 Harmonic Current Measurement

Mode A

Test Duration	5 min	Fundamental Voltage / Ampere	230.435 Vrms / 0.808 Arms
Power Consumption	169.3 W	Power Frequency	50 Hz
Power Factor	0.926	Environmental Conditions	20 °C, 80 % RH
Tested By	Xun Lee		

Harm#	Harms (avg) (A)	100% Limit (A)	Harms (max) (A)	150% Limit (A)
1	0.748	-	1.500	-
2	0.001	1.080	0.002	1.620
3	0.254	2.300	0.260	3.450
4	0.001	0.430	0.002	0.645
5	0.053	1.140	0.055	1.710
6	0.001	0.300	0.001	0.450
7	0.023	0.770	0.025	1.155
8	0.001	0.230	0.001	0.345
9	0.018	0.400	0.021	0.600
10	0.001	0.184	0.001	0.276
11	0.007	0.330	0.008	0.495
12	0.001	0.153	0.001	0.230
13	0.013	0.210	0.014	0.315
14	0.001	0.131	0.002	0.197
15	0.009	0.150	0.009	0.225
16	0.001	0.115	0.003	0.173
17	0.008	0.132	0.009	0.198
18	0.001	0.102	0.002	0.153
19	0.005	0.118	0.007	0.178
20	0.001	0.092	0.002	0.138
21	0.008	0.107	0.009	0.161
22	0.001	0.084	0.003	0.125
23	0.006	0.098	0.006	0.147
24	0.001	0.077	0.002	0.115
25	0.006	0.090	0.007	0.135
26	0.001	0.071	0.001	0.107
27	0.006	0.083	0.006	0.125
28	0.001	0.066	0.001	0.099
29	0.004	0.078	0.004	0.116
30	0.001	0.061	0.001	0.092
31	0.004	0.073	0.006	0.109
32	0.001	0.058	0.001	0.086
33	0.006	0.068	0.007	0.102
34	0.001	0.054	0.001	0.081
35	0.003	0.064	0.003	0.096
36	0.001	0.051	0.001	0.077
37	0.002	0.061	0.003	0.091
38	0.001	0.048	0.001	0.073
39	0.006	0.058	0.006	0.087
40	0.001	0.046	0.001	0.069

Note: Dynamic limits were applied for this test. The highest harmonics values in the above table may not occur at the same window as the maximum harmonics/limit ratio.

7.6 Voltage Fluctuations and Flicker Measurement

Mode A

Observation (Tp)	10 min		
Input Power	230 Vac, 50 Hz	Environmental Conditions	20 °C, 80 % RH
Tested By	Xun Lee		

Test Parameter	Measurement Value	Limit	Remarks
P_{st}	0.166	1.00	Pass
P_{lt}	0.072	0.65	Pass
T_{max} (ms)	0.000	500	Pass
d_{max} (%)	0.030	4.00	Pass
d_c (%)	0.000	3.30	Pass

Notes:

1. P_{st} means short-term flicker indicator.
2. P_{lt} means long-term flicker indicator.
3. T_{max} means accumulated time value of $d(t)$ with a deviation exceeding 3.3 %.
4. d_{max} means maximum relative voltage change.
5. d_c means maximum relative steady-state voltage change.

7.7 Electrostatic Discharges (ESD)

Mode A

For EN 55035

Input Power	AC 230V / 50Hz	Environmental conditions	24 °C, 46 % RH 1003 mbar
Tested by	Eric Liao		

Test Results of Direct Application

Discharge Level (kV)	Polarity (+/-)	Test Point	Contact Discharge	Air Discharge	Performance Criteria
2	+/-	1 - 10	Note 1	---	A
4	+/-	1 - 10	Note 2	---	B
2, 4, 8	+/-	19	---	Note 1	A
2, 4	+/-	11 - 18	---	Note 1	A
8	+/-	11 - 18	---	Note 2	B

Description of test points of direct application: Please refer to following page for representative mark only.

Test Results of Indirect Application

Discharge Level (kV)	Polarity (+/-)	Test Point	Horizontal Coupling Plane	Vertical Coupling Plane	Performance Criteria
2, 4	+/-	Four Side	Note 1	Note 1	A

Description of test points of indirect application:

1. Front side 2. Rear side 3. Right side 4. Left side

Please refer to the attached page for description of test points.

Notes:

1. The EUT is operated normal during the test.
2. The output monitor's panel have flicker during the test, but self-recoverable after test.

Description of test point

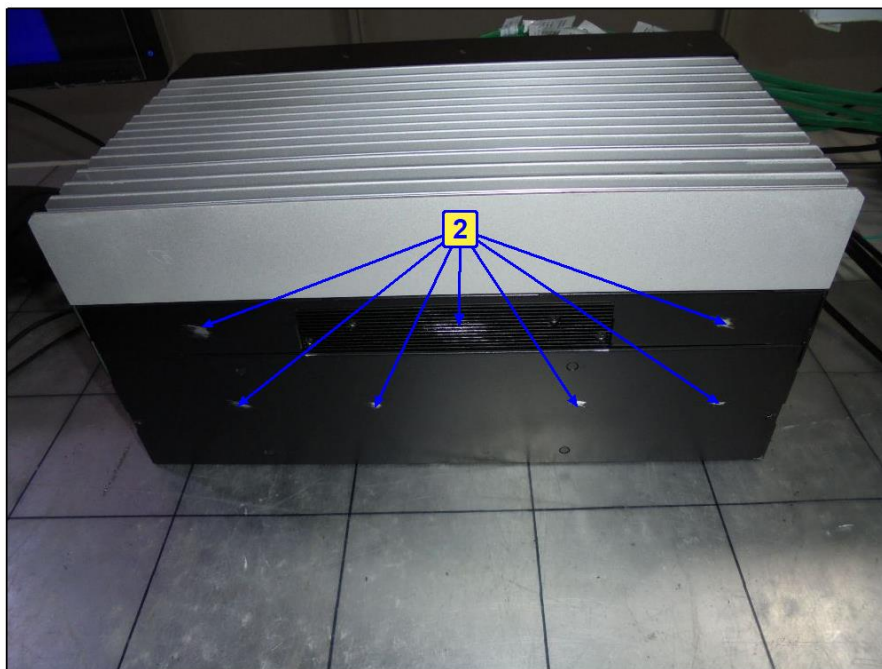
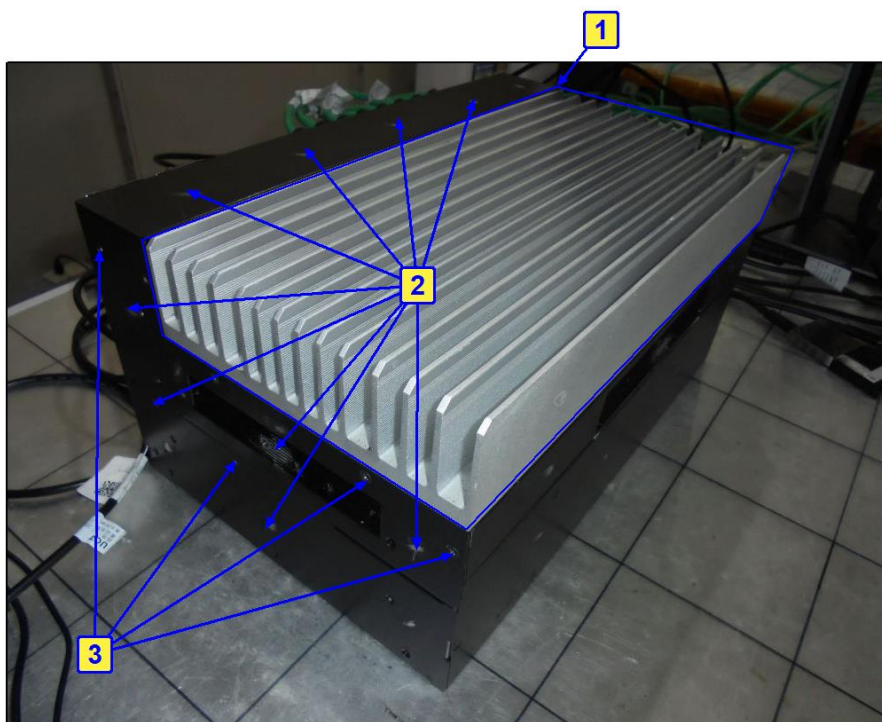

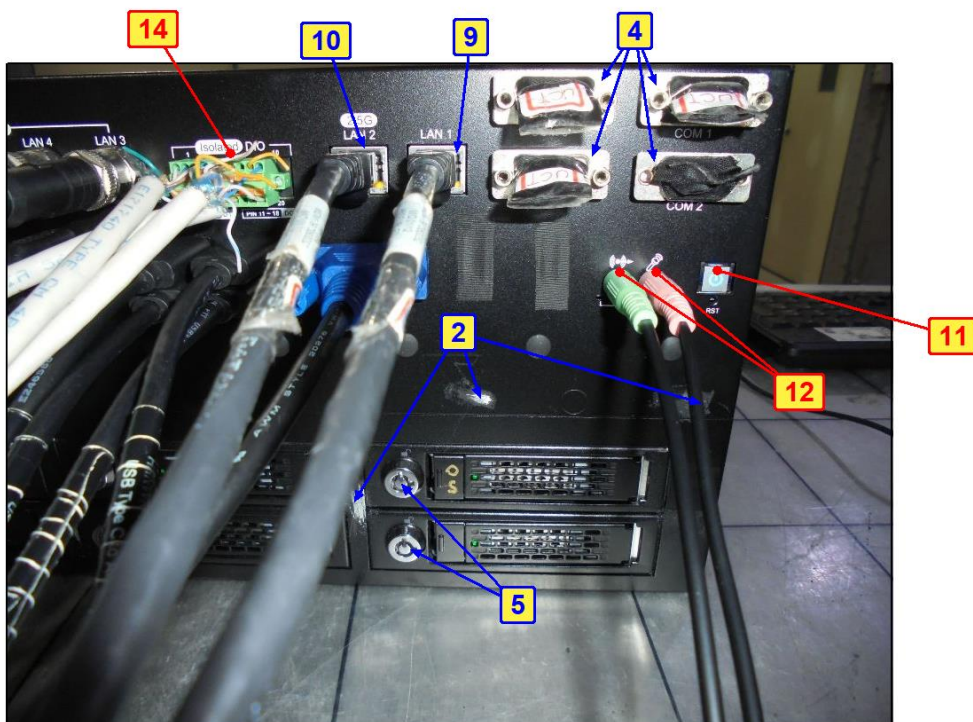
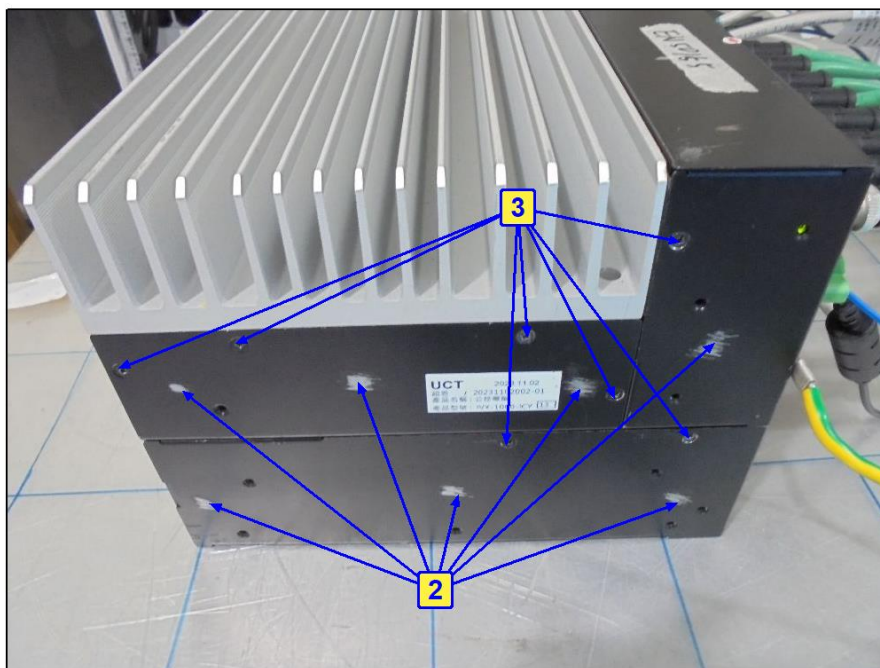

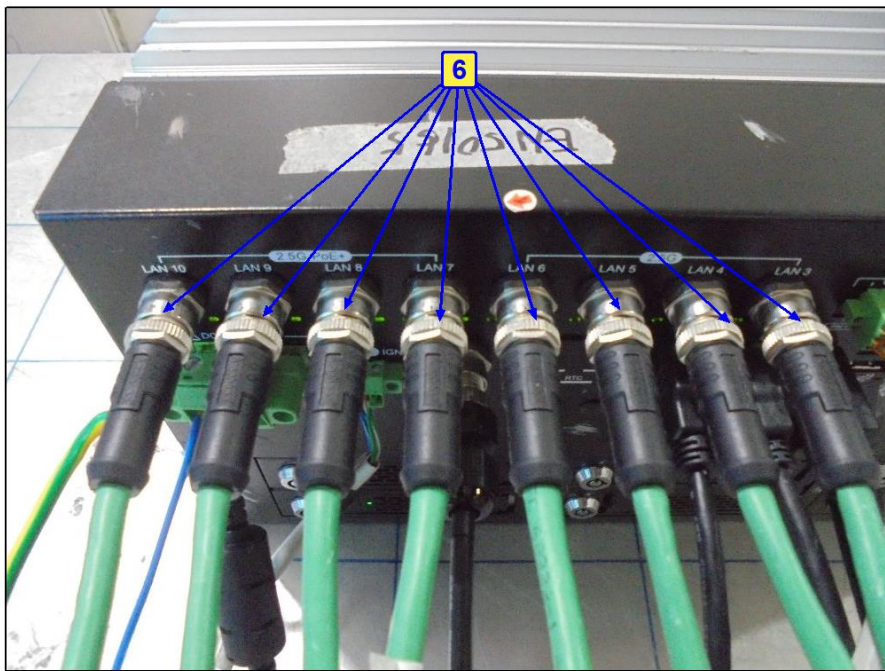
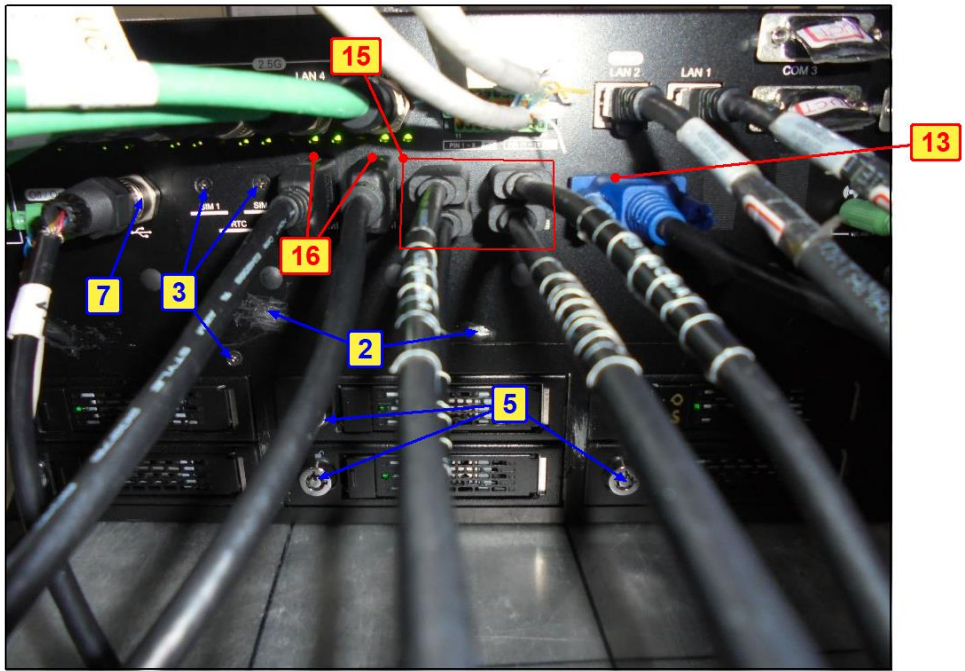

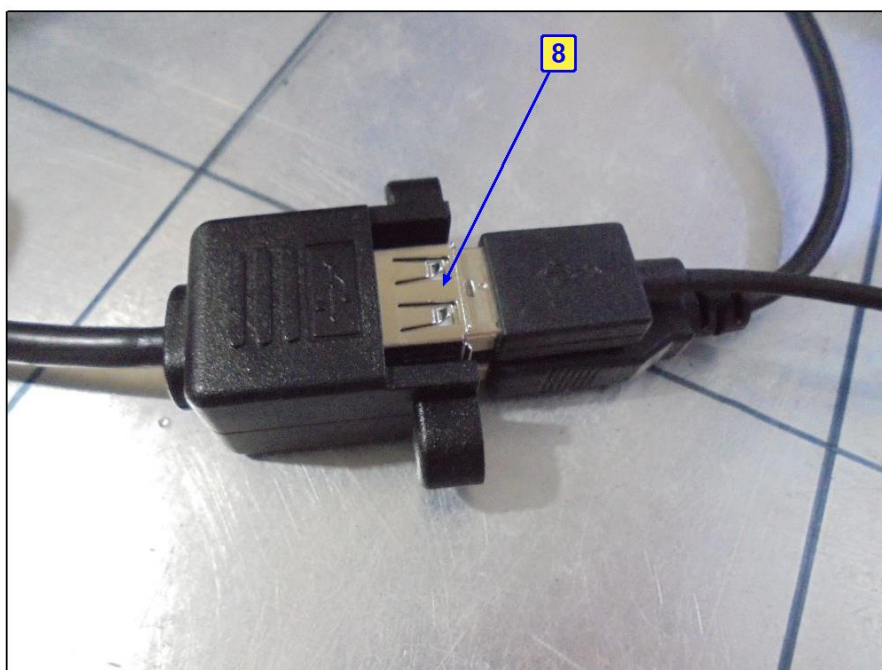
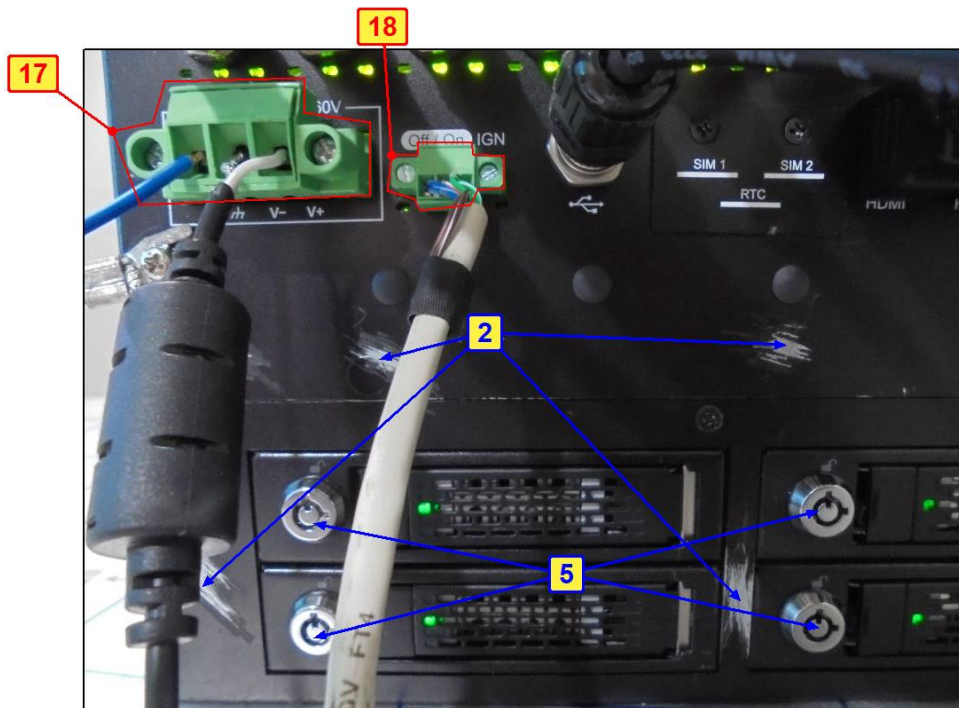

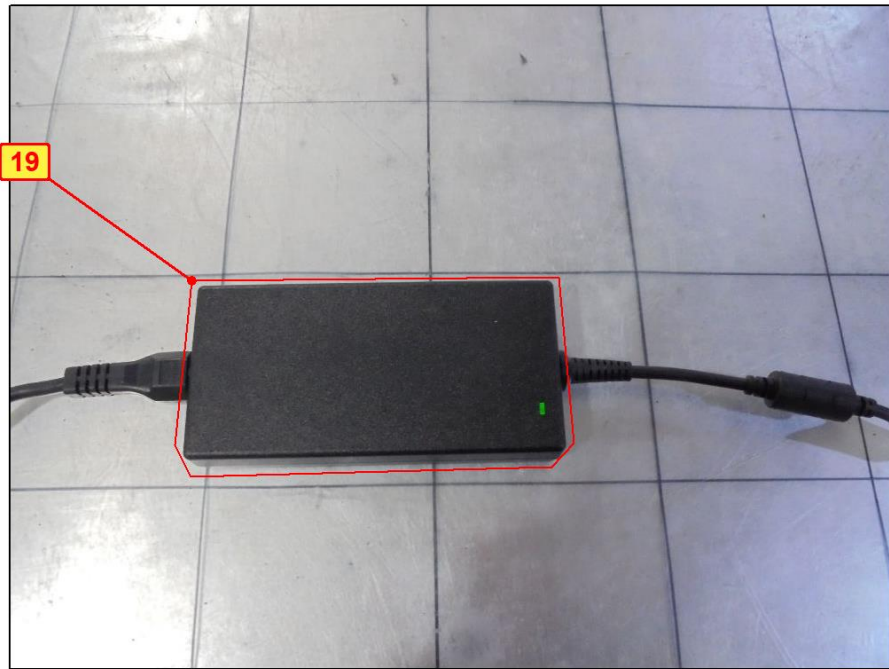

7.8 Radio Frequency Electromagnetic Field (RS)

Mode A

For EN 55035

Input Power	AC 230V / 50Hz	Environmental conditions	24 °C, 75 % RH 1000 mbar
Tested by	Eric Liao		

Frequency (MHz)	Polarity	Azimuth(°)	Applied Field Strength		Observation	Performance Criteria
			(V/m)	Modulation		
80 - 1000	V&H	0, 90, 180, 270	3	80% AM (1kHz)	Note 1	A
1800, 2600, 3500, 5000	V&H	0, 90, 180, 270	3	80% AM (1kHz)	Note 1	A
80 - 1000	V&H	0, 90, 180, 270	3	80% AM (1kHz)	Note 2	A
1800, 2600, 3500, 5000	V&H	0, 90, 180, 270	3	80% AM (1kHz)	Note 2	A

Notes:

1. The EUT is operated normal during the test.
2. Audio Out Function (Ear Phone out) Electrical Reference level Pass.

7.9 Fast Transients Common Mode (EFT)

Mode A

For EN 55035

Input Power	AC 230V / 50Hz	Environmental conditions	20 °C, 74 % RH 1002 mbar
Tested by	Eric Liao		

Input AC power port				
Voltage (kV)	Test Point	Polarity (+/-)	Observation	Performance Criteria
1	L	+/-	Note	A
1	N	+/-	Note	A
1	PE	+/-	Note	A
1	L-N-PE	+/-	Note	A

Wired network and signal/ control port				
Voltage (kV)	Test Point	Polarity (+/-)	Observation	Performance Criteria
0.5	LAN 1	+/-	Note	A
0.5	LAN 2	+/-	Note	A
0.5	LAN 3	+/-	Note	A
0.5	LAN 10	+/-	Note	A

Note: The EUT is operated normal during the test.

7.10 Surges

Mode A

For EN 55035

Input Power	AC 230V / 50Hz	Environmental conditions	20 °C, 74 % RH 1010 mbar
Tested by	Bernie Lu		

Input AC power port					
Voltage (kV)	Test Point	Azimuth(°)	Polarity (+/-)	Observation	Performance Criteria
0.5, 1	L-N	90, 270	+/-	Note	A
0.5, 1, 2	L-PE	90, 270	+/-	Note	A
0.5, 1, 2	N-PE	90, 270	+/-	Note	A

Note: The EUT is operated normal during the test.

7.11 Radio Frequency Common Mode (CS)

Mode A

For EN 55035

Input Power	AC 230V / 50Hz	Environmental conditions	22 °C, 74 % RH 1002 mbar
Tested by	Eric Liao		

Input AC power port							
Frequency (MHz)	Level (V rms)	Modulation	Tested Line	Injection Method	Return Path	Observation	Performance Criteria
0.15 – 10	3	80% AM (1kHz)	AC power	CDN-M3	CDN-M1	Note 1	A
10 – 30	3 ~ 1	80% AM (1kHz)	AC power	CDN-M3	CDN-M1	Note 1	A
30 – 80	1	80% AM (1kHz)	AC power	CDN-M3	CDN-M1	Note 1	A
0.15 – 10	3	80% AM (1kHz)	AC power	CDN-M3	CDN-M1	Note 2	A
10 – 30	3 ~ 1	80% AM (1kHz)	AC power	CDN-M3	CDN-M1	Note 2	A
30 – 80	1	80% AM (1kHz)	AC power	CDN-M3	CDN-M1	Note 2	A

Wired network and signal/ control port							
Frequency (MHz)	Level (V rms)	Modulation	Tested Line	Injection Method	Return Path	Observation	Performance Criteria
0.15 – 10	3	80% AM (1kHz)	LAN 1	CDN-ST08A	CDN-M1	Note 1	A
10 – 30	3 ~ 1	80% AM (1kHz)	LAN 1	CDN-ST08A	CDN-M1	Note 1	A
30 – 80	1	80% AM (1kHz)	LAN 1	CDN-ST08A	CDN-M1	Note 1	A
0.15 – 10	3	80% AM (1kHz)	LAN 1	CDN-ST08A	CDN-M1	Note 2	A
10 – 30	3 ~ 1	80% AM (1kHz)	LAN 1	CDN-ST08A	CDN-M1	Note 2	A
30 – 80	1	80% AM (1kHz)	LAN 1	CDN-ST08A	CDN-M1	Note 2	A
0.15 – 10	3	80% AM (1kHz)	LAN 2	CDN-ST08A	CDN-M1	Note 1	A
10 – 30	3 ~ 1	80% AM (1kHz)	LAN 2	CDN-ST08A	CDN-M1	Note 1	A
30 – 80	1	80% AM (1kHz)	LAN 2	CDN-ST08A	CDN-M1	Note 1	A
0.15 – 10	3	80% AM (1kHz)	LAN 2	CDN-ST08A	CDN-M1	Note 2	A
10 – 30	3 ~ 1	80% AM (1kHz)	LAN 2	CDN-ST08A	CDN-M1	Note 2	A
30 – 80	1	80% AM (1kHz)	LAN 2	CDN-ST08A	CDN-M1	Note 2	A
0.15 – 10	3	80% AM (1kHz)	LAN 3	CDN-ST08A	CDN-M1	Note 1	A
10 – 30	3 ~ 1	80% AM (1kHz)	LAN 3	CDN-ST08A	CDN-M1	Note 1	A
30 – 80	1	80% AM (1kHz)	LAN 3	CDN-ST08A	CDN-M1	Note 1	A
0.15 – 10	3	80% AM (1kHz)	LAN 3	CDN-ST08A	CDN-M1	Note 2	A
10 – 30	3 ~ 1	80% AM (1kHz)	LAN 3	CDN-ST08A	CDN-M1	Note 2	A
30 – 80	1	80% AM (1kHz)	LAN 3	CDN-ST08A	CDN-M1	Note 2	A
0.15 – 10	3	80% AM (1kHz)	LAN 10	CDN-ST08A	CDN-M1	Note 1	A
10 – 30	3 ~ 1	80% AM (1kHz)	LAN 10	CDN-ST08A	CDN-M1	Note 1	A
30 – 80	1	80% AM (1kHz)	LAN 10	CDN-ST08A	CDN-M1	Note 1	A
0.15 – 10	3	80% AM (1kHz)	LAN 10	CDN-ST08A	CDN-M1	Note 2	A
10 – 30	3 ~ 1	80% AM (1kHz)	LAN 10	CDN-ST08A	CDN-M1	Note 2	A
30 – 80	1	80% AM (1kHz)	LAN 10	CDN-ST08A	CDN-M1	Note 2	A

Notes:

1. The EUT is operated normal during the test.
2. Audio Out Function (Ear Phone out) Electrical Reference level Pass.

7.12 Power Frequency Magnetic Field (PFMF)

Mode A

For EN 55035

Input Power	AC 230V / 50Hz	Environmental conditions	20 °C, 80 % RH 1010 mbar
Tested by	Xun Lee		

Application	Frequency (Hz)	Field Strength (A/m)	Observation	Performance Criteria
X - Axis	50	1	Note	A
Y - Axis	50	1	Note	A
Z - Axis	50	1	Note	A

Note: The EUT is operated normal during the test.

7.13 Voltage Dips and Interruptions (DIP)

Mode A

For EN 55035

Nominal Input Power	AC 230V / 50Hz	Environmental conditions	20 °C, 80 % RH 1010 mbar
Tested by	Xun Lee		

Input Power for testing: <u>230Vac, 50 Hz</u> (Nominal input Voltage)					
Voltage Residual(%)	Duration (cycle)	Interval (sec)	Times	Observation	Performance Criteria
<5	0.5	10	3	Note 1	A
70	25	10	3	Note 1	A
<5	250	10	3	Note 2	C

Input Power for testing: <u>240Vac, 50 Hz</u> (Maximum rated input voltage)					
Voltage Residual(%)	Duration (cycle)	Interval (sec)	Times	Observation	Performance Criteria
<5	0.5	10	3	Note 1	A
70	25	10	3	Note 1	A
<5	250	10	3	Note 2	C

Input Power for testing: <u>100Vac, 50 Hz</u> (Minimum rated input voltage)					
Voltage Residual(%)	Duration (cycle)	Interval (sec)	Times	Observation	Performance Criteria
<5	0.5	10	3	Note 1	A
70	25	10	3	Note 2	C
<5	250	10	3	Note 2	C

Notes:

1. The EUT is operated normal during the test.
2. The EUT shut down during the test, it need operator to reboot after the test.

8 Pictures of Test Arrangements

8.1 Conducted Emissions from Power Ports

Mode A



8.2 Conducted Emissions from Wired Network Ports

Mode A

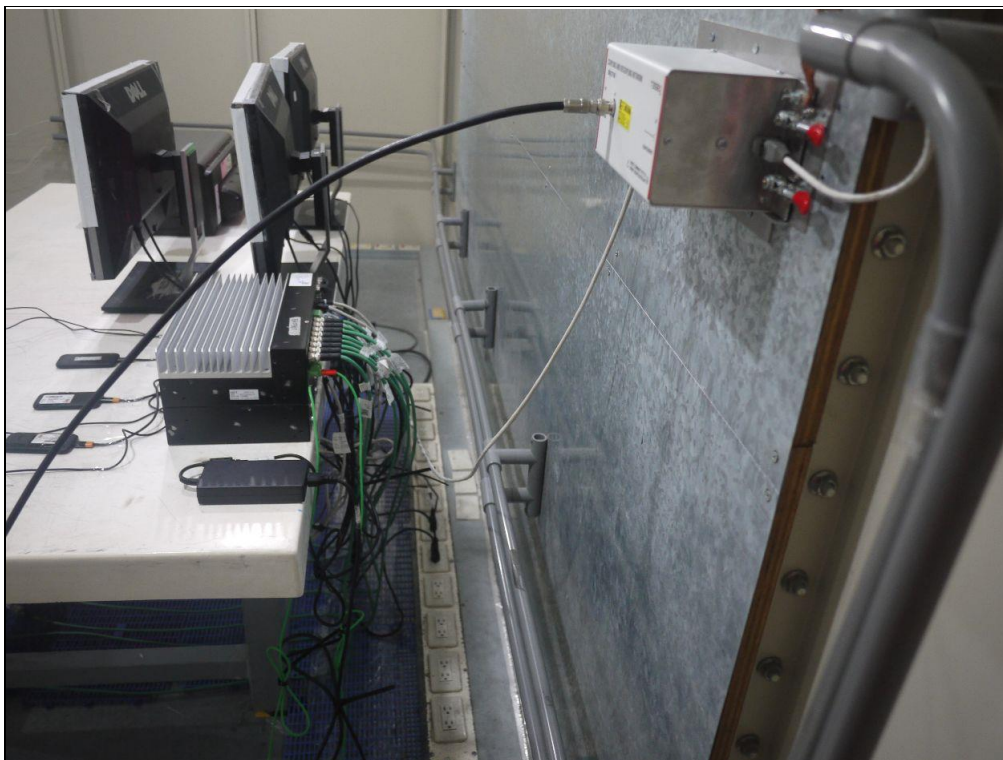

Mode B



Mode C

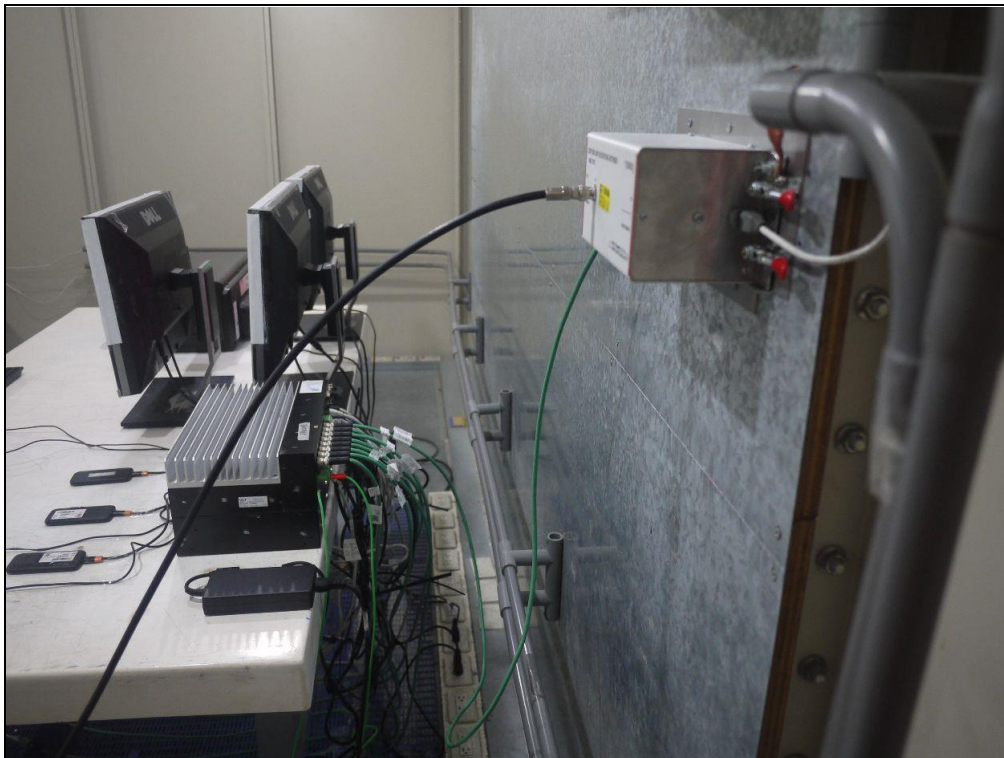
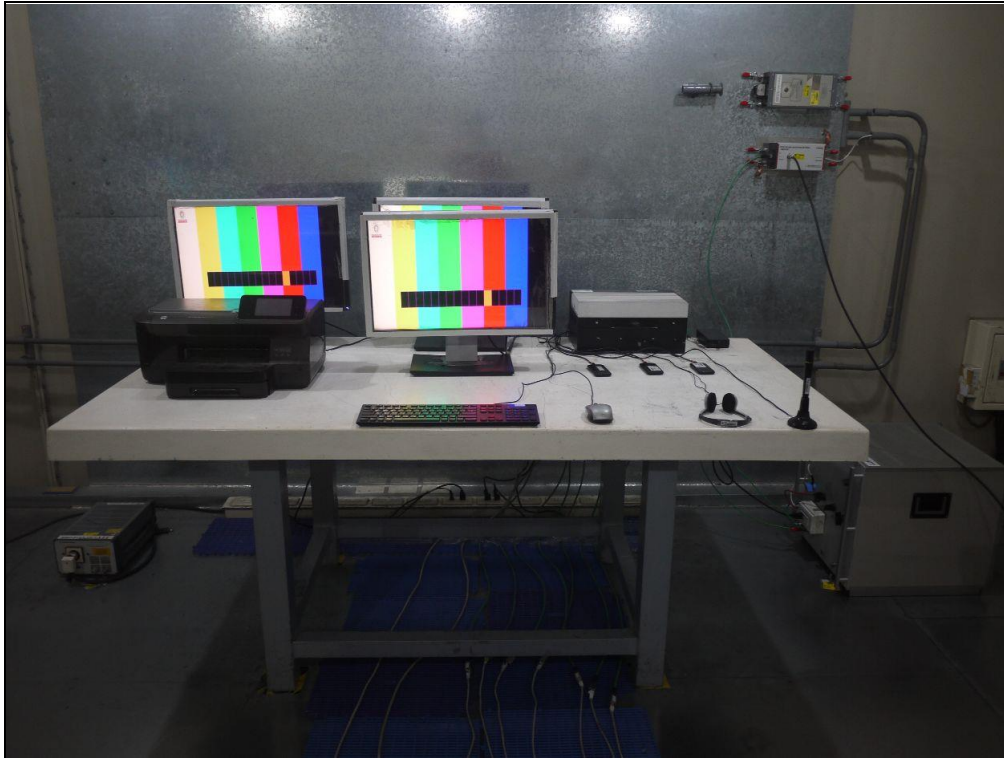

Mode D

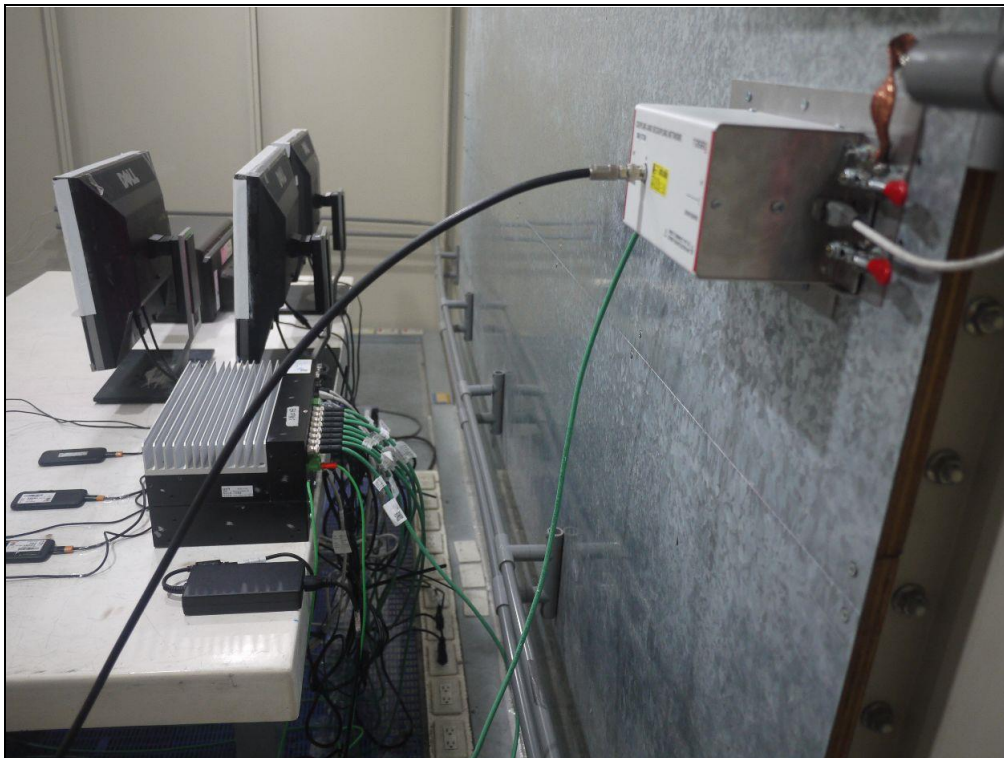
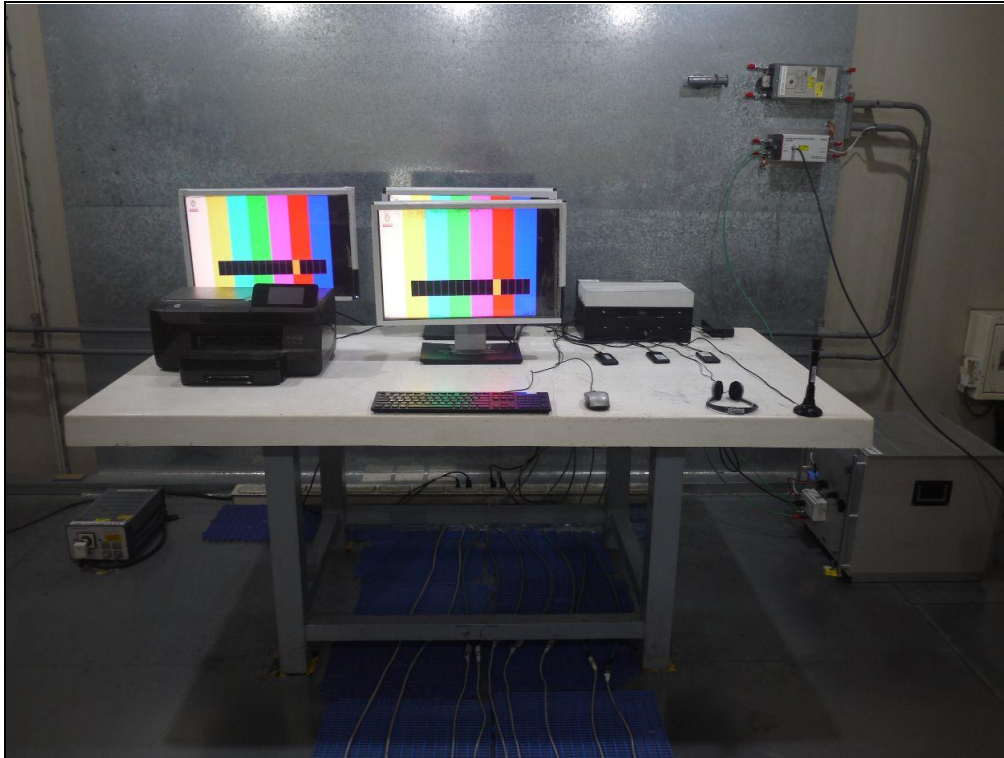

8.3 Radiated Emissions up to 1 GHz

Mode A



8.4 Radiated Emissions above 1 GHz

Mode A

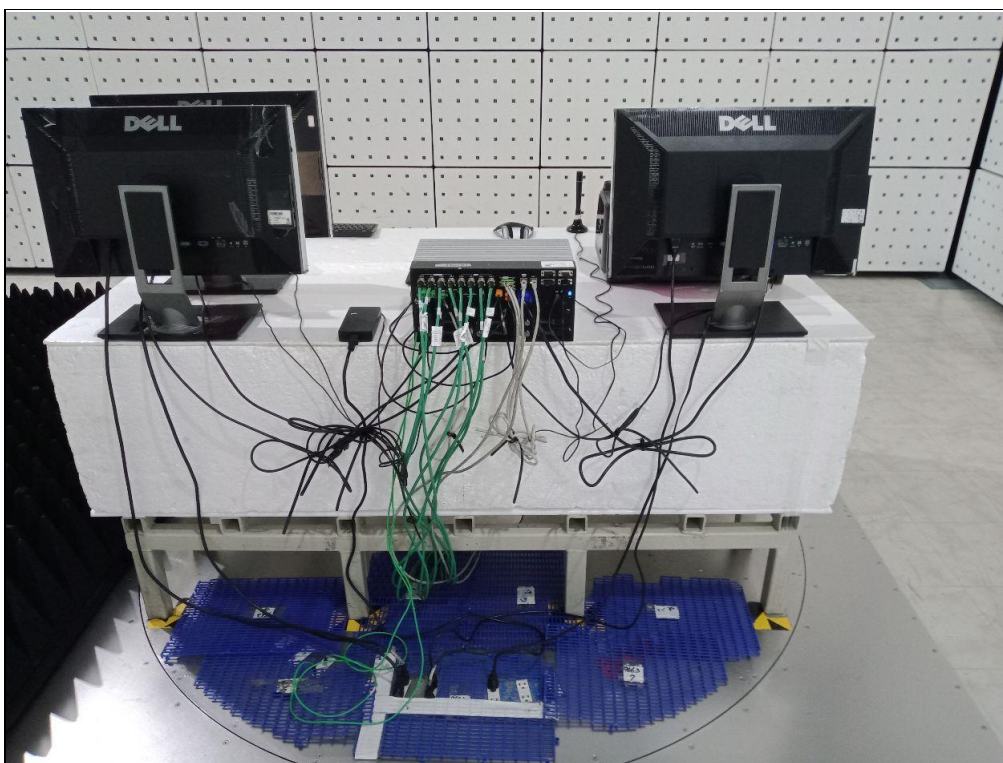

8.5 Harmonic Current Measurement

Mode A



8.6 Voltage Fluctuations and Flicker Measurement

Mode A



8.7 Electrostatic Discharges (ESD)

Mode A

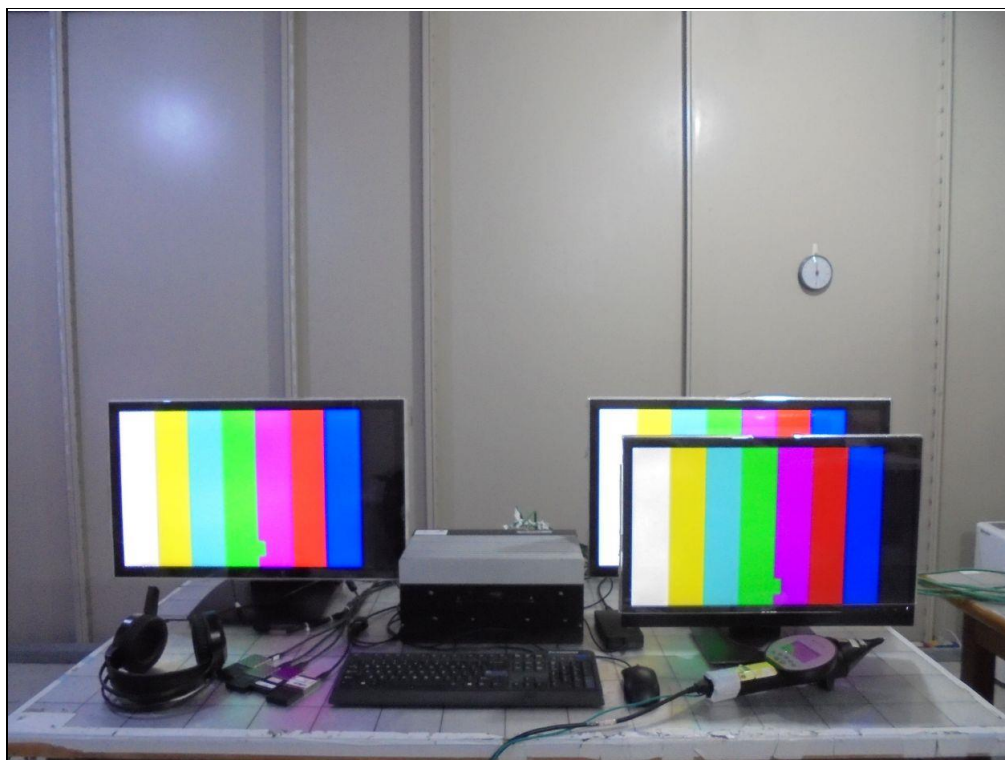

8.8 Radio Frequency Electromagnetic Field (RS)

Mode A

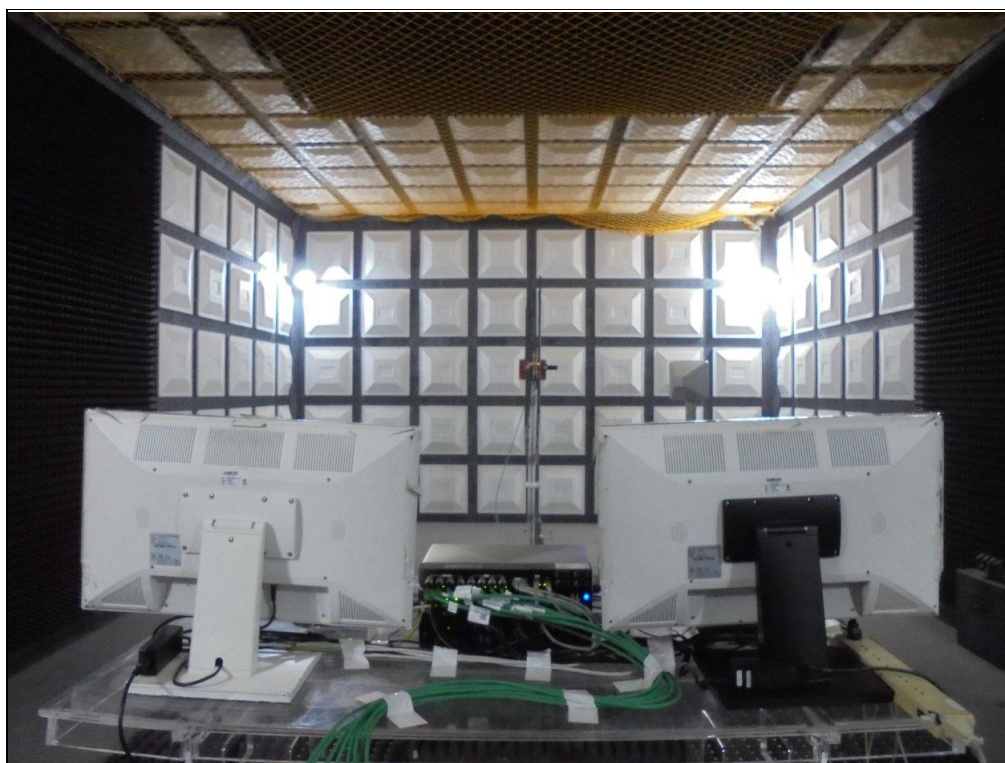
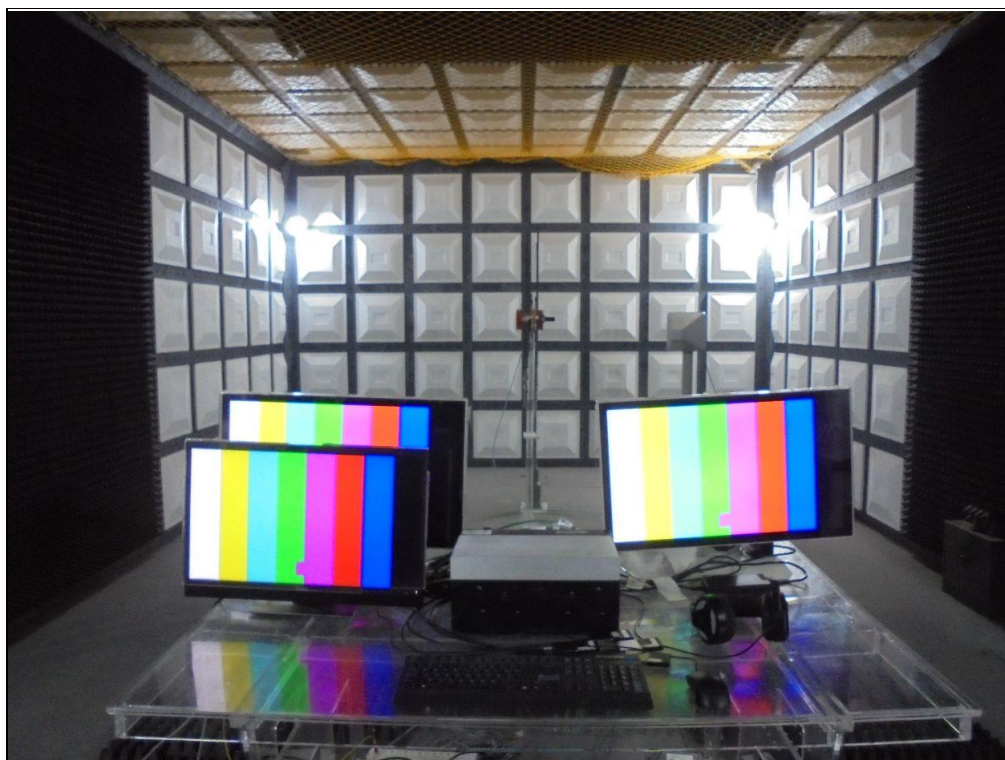

8.9 Fast Transients Common Mode (EFT)

Mode A

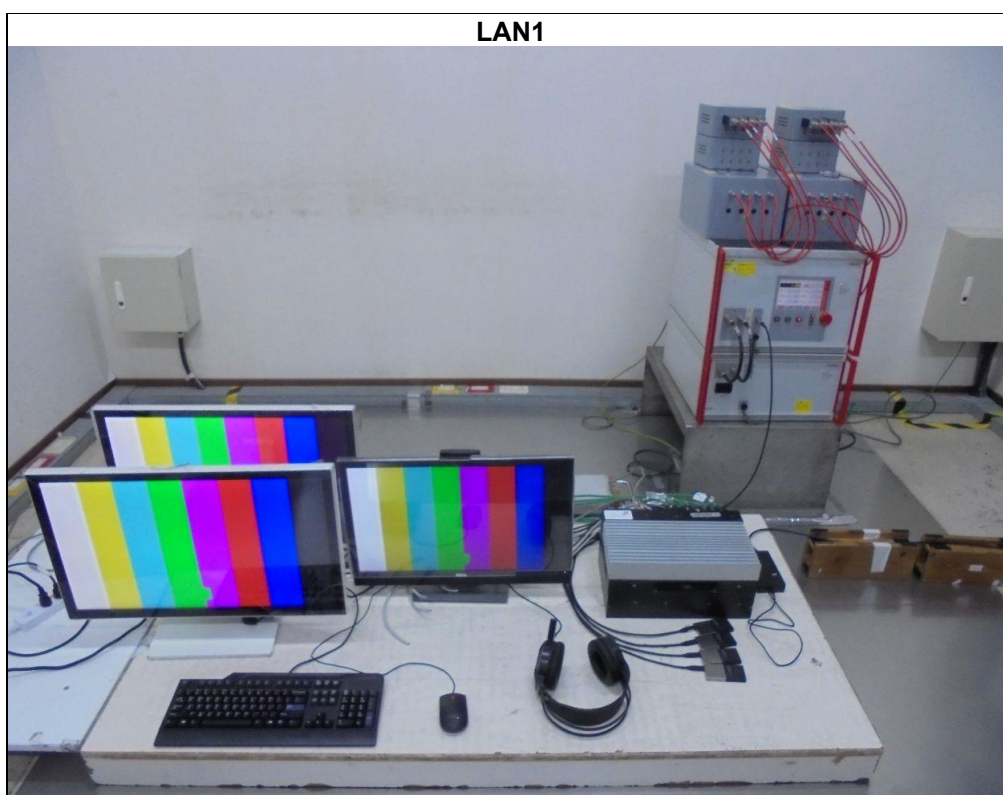
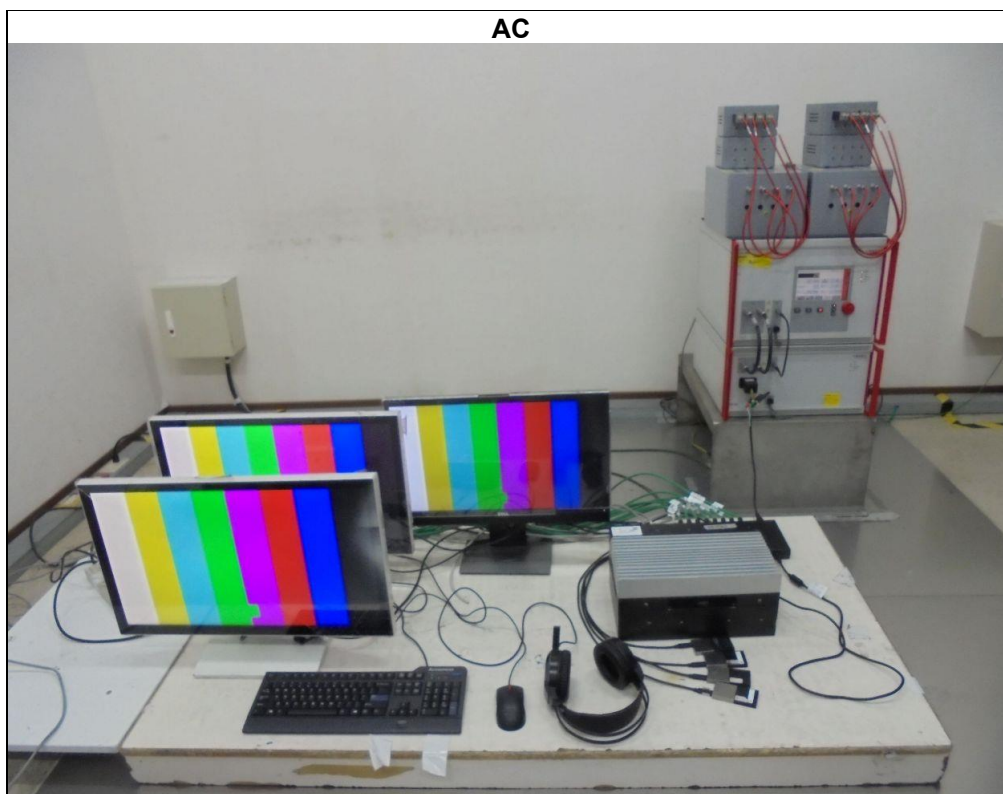

LAN2

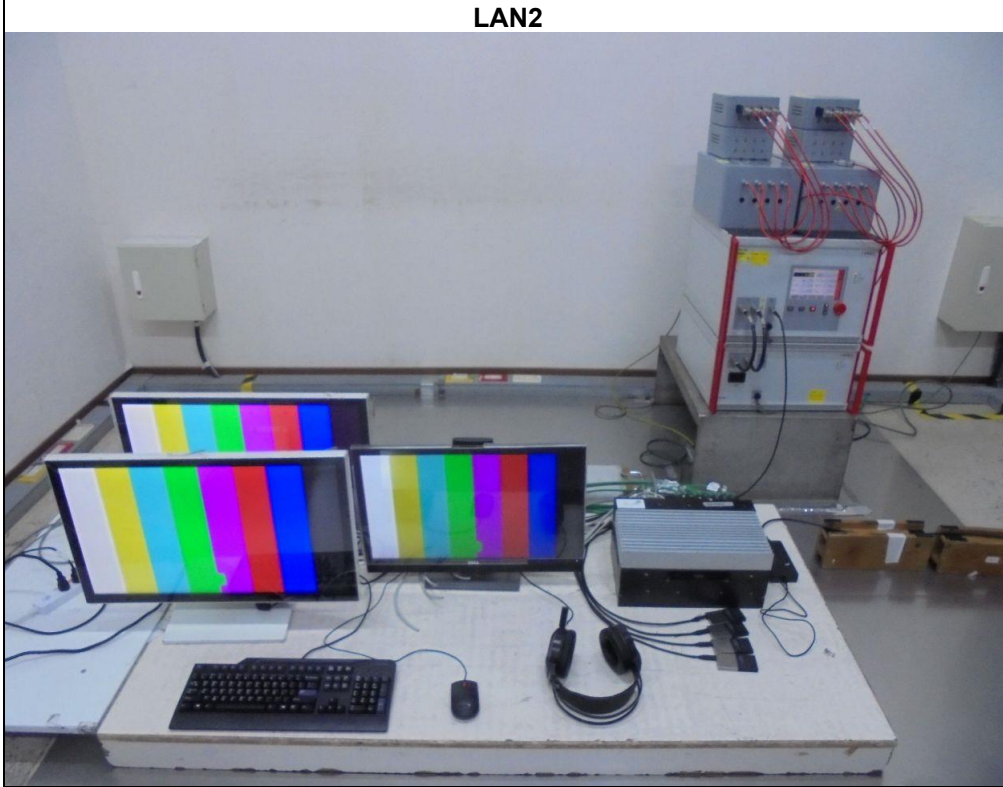

LAN3



LAN10



8.10 Surges

Mode A



8.11 Radio Frequency Common Mode (CS)

Mode A

AC

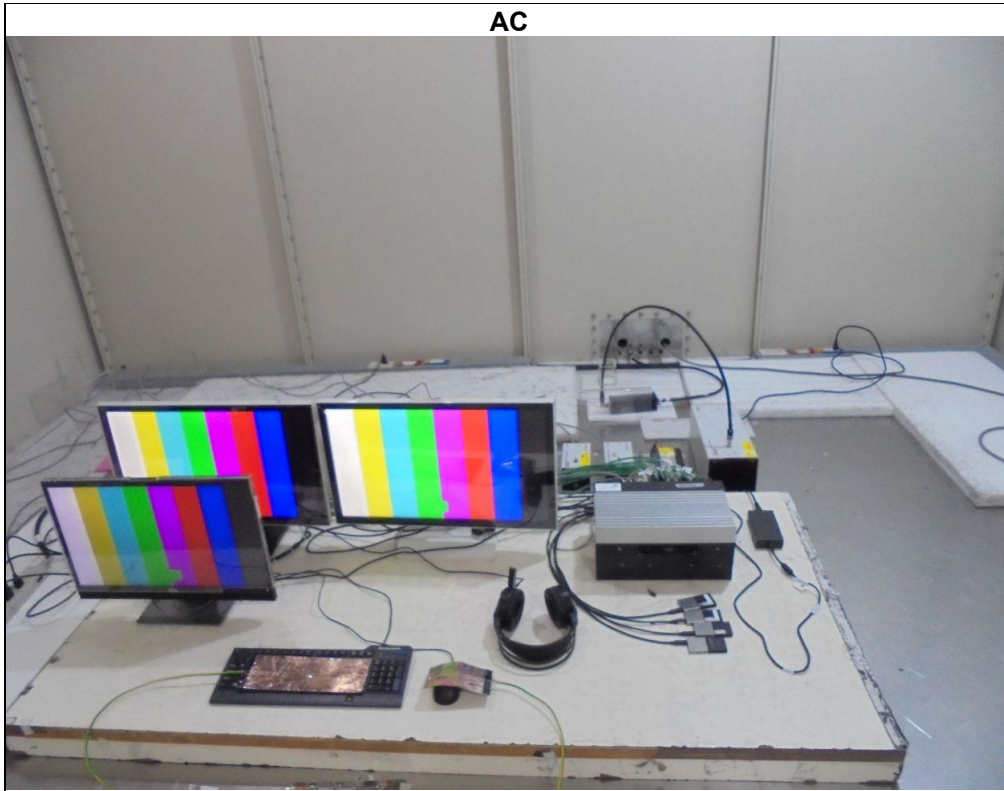

LAN1

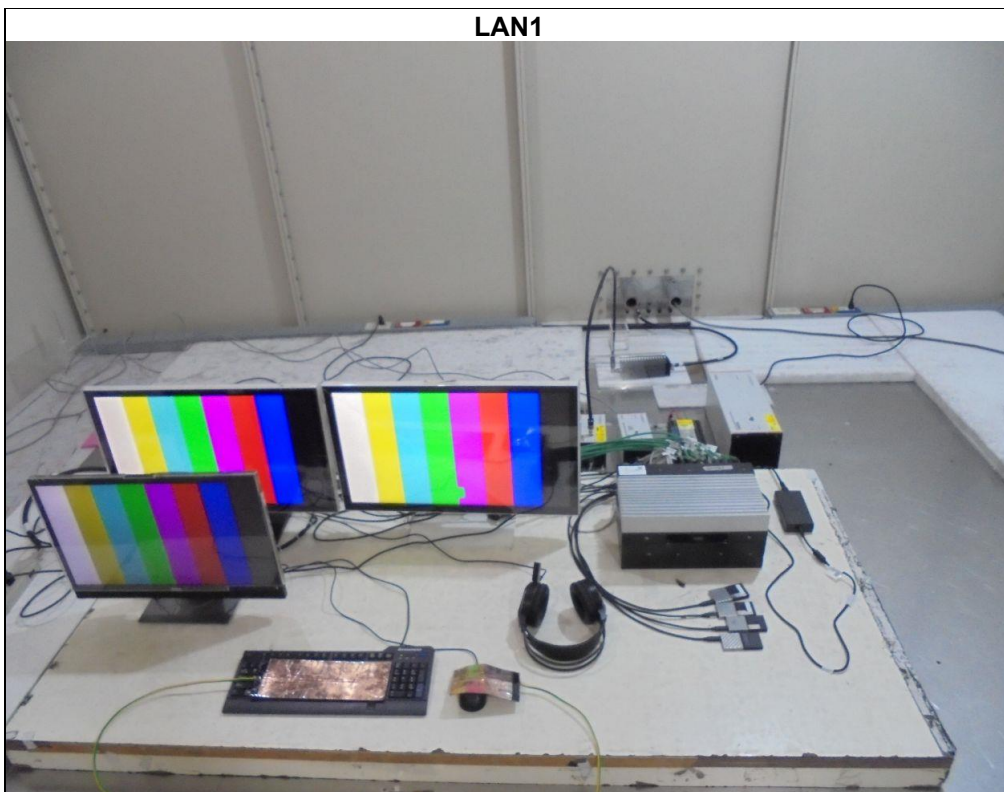

LAN2

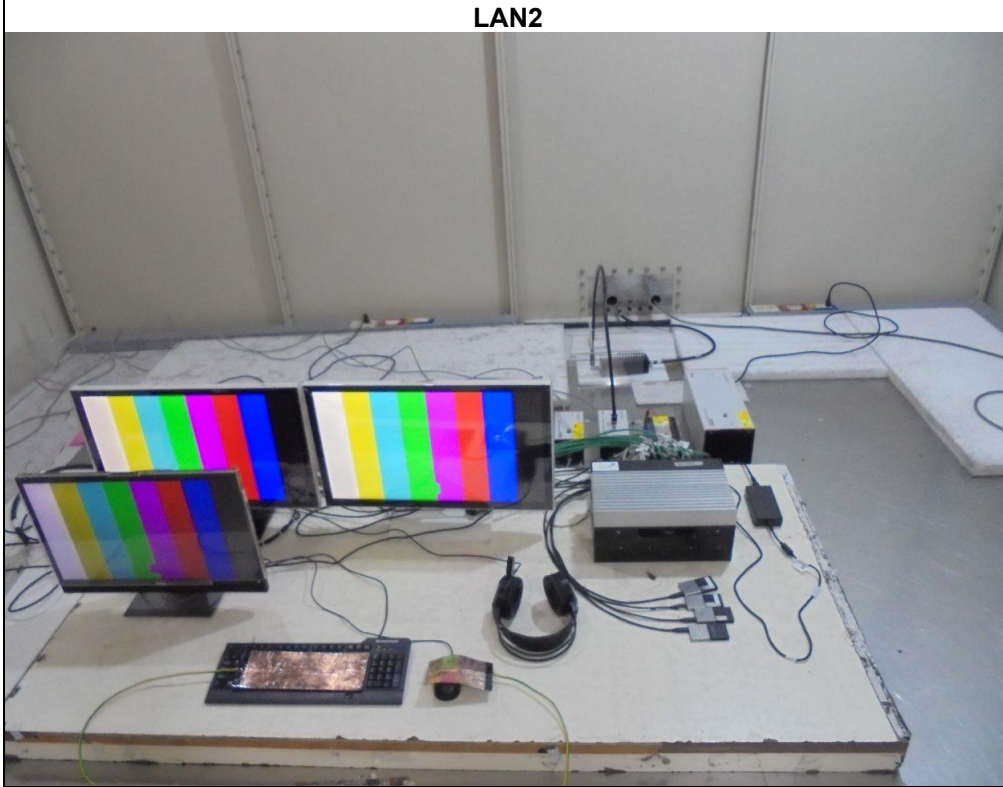

LAN3

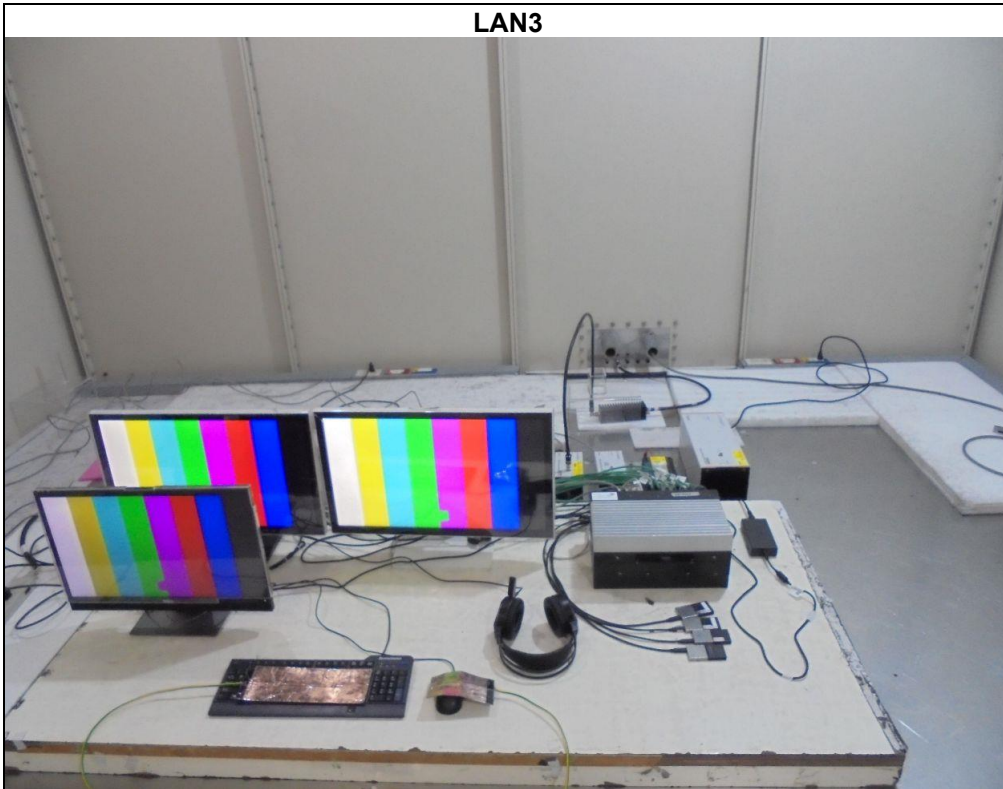

LAN10

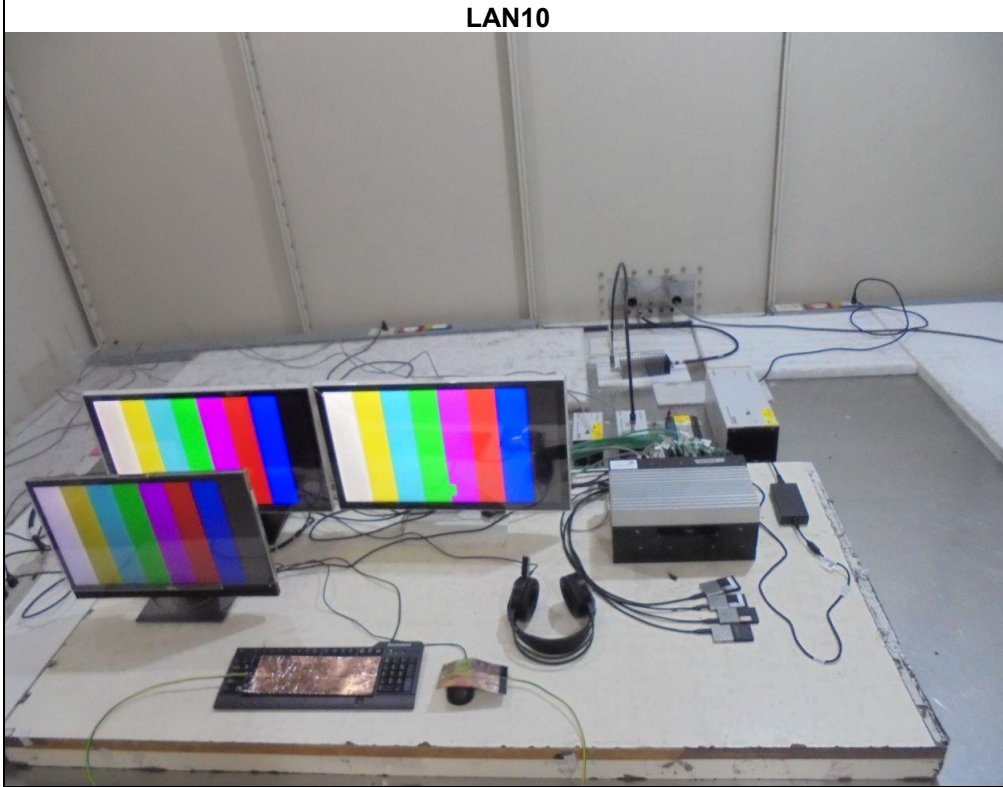

8.12 Power Frequency Magnetic Field (PFMF)

Mode A



8.13 Voltage Dips and Interruptions (DIP)

Mode A



9 Information of the Testing Laboratories

We, Bureau Veritas Consumer Products Services (H.K.) Ltd., Taoyuan Branch, were founded in 1988 to provide our best service in EMC, Radio, Telecom and Safety consultation. Our laboratories are FCC recognized accredited test firms and accredited according to ISO/IEC 17025.

If you have any comments, please feel free to contact us at the following:

Lin Kou EMC/RF Lab

Tel: 886-2-26052180

Fax: 886-2-26051924

Hsin Chu EMC/RF/Telecom Lab

Tel: 886-3-6668565

Fax: 886-3-6668323

Hwa Ya EMC/RF/Safety Lab

Tel: 886-3-3183232

Fax: 886-3-3270892

Email: service.adt@bureauveritas.com

Web Site: <http://ee.bureauveritas.com.tw>

The address and road map of all our labs can be found in our web site also.

--- END ---